

# AGATI

## Welcome to AGATI

AGATI Furniture is known for its innovative designs, durable construction and exceptional customer service. Throughout the years, the name AGATI has become synonymous with the words classic, quality and value. Offering a commitment that extends well beyond its competitors, AGATI has earned its reputation as a premier manufacturer and resource to architects and designers across markets.

Furniture styles range from classic, standard collections to contemporary designs and custom modifications. Each year brings more product offerings and a wider range of styles without compromising the integrity of the product. In the 1980's AGATI launched its library division. Word of mouth praise from librarians, architects and designers across the country helped AGATI build its name and solidify its foothold in the market. AGATI attributes its strong client base and repeat customers to solid relationships, a willingness to listen and individualized attention.

At the foundation of AGATI is its Design and Engineering department. Offering years of expertise, an in-house Design and Engineering team takes the project from drawing board to delivery. Furniture is made specifically for each project in order to meet the client's needs. AGATI understands the value of being a resource to both the client and the designer and takes every effort to ensure the greatest long-term return on investment.

AGATI collections are original designs and are constructed to endure constant heavy use. Wood side and arm chairs are assembled with mortise and tenon joints that are secured with hardwood metal pins, making the strongest joint possible. Chairs feature one-piece, steam bent, solid lumber back posts for superior stability and strength. Chair backs are engineered with lumbar support shaped into the back splats or slats, as well as designed for patron comfort. Table bases are constructed with end aprons and leg stretchers, and are mounted to the bottom face of the table tops with steel plates secured with mechanical fasteners. This structure provides a foundation for a solid, long lasting work surface. The time, effort, and care expended in the manufacturing of these products ensures many years of safe use.

In a world where resources are at a premium, AGATI takes its role seriously by staying current with green processes and technological advances. As clients increasingly turn to the internet for instant information retrieval, AGATI is able to provide faster access to resources through [www.agati.com](http://www.agati.com). Keeping the website fresh and timely allows AGATI to scale back on the amount of printed materials distributed.

The information age also translates into AGATI's furniture as power and data wire management issues are addressed before undertaking a project's furnishing designs. And while facilities are equipped with the most modern equipment and technology, traditional spindle carving and profile shapers still remain AGATI specialties. It is this contrast that demonstrates the foundation of AGATI – an ability to stay true to its roots in traditional design, while keeping in step with an ever-changing world primed for AGATI's inventive perspective on furniture design.

Ultimately, Agati furniture is built to stand the test of time. We believe in extraordinary architecture and remarkable furniture, and we look forward to enhancing your environment for years to come. Thank you for your interest in AGATI.



Agati-Inc



Agati Inc.



AgatiFurniture



Agati-Furniture



AgatiFurniture



Agati Furniture





## Warranty

AGATI, Inc. manufactures its products to the highest quality standards. Therefore, AGATI products are warranted against all defects in materials and workmanship for a period of ten years from date of delivery. This warranty does not extend to COM, COL or any other customer supplied materials. During the warranty period, AGATI will, at its discretion, repair or replace defective merchandise free of charge.

The AGATI warranty is against defects in workmanship that would lead to the following: veneer lifting or peeling, glue joint failure, and wood joints pulling apart. AGATI handcrafts and finishes its products using the finest hardwoods and traditional hand finishing techniques. AGATI uses finishing techniques that are intended to highlight the inherent beauty of the wood used in its products. Depending upon the figure of the wood used, certain areas may absorb the stain differently than others. Wood is a natural product and will naturally have slight flaws and imperfections, which enhance the overall beauty. Customers should be aware that all finishes will mellow with age. Since wood is a natural material, some expansion and contraction is to be expected. The foregoing is not to be considered a defect in the materials or manufacturing process used and is not covered under warranty.

The AGATI warranty covers the lifting of any plastic laminate from the substrate but can only underwrite the laminate manufacturer's guarantee against scratching and chipping.

This warranty does not extend to damage resulting from shipping, accident, alteration, misuse, tampering, negligence, abuse, acts of God, or ordinary wear and tear. This warranty is given expressly and in lieu of all other warranties, expressed or implied, of merchantability and fitness for particular purpose and constitutes the only warranty made by AGATI. No warranty is made with respect to non-standard materials selected by and used at the request of the customer. No merchandise may be returned to AGATI without AGATI's written approval.

In addition to a ten year warranty, AGATI stands by a philosophy that buying AGATI is buying the future. AGATI constructs all of its products to enjoy a lifetime of use. However, furniture inherently ages and AGATI understands needs may change throughout a product's life cycle. Therefore, AGATI will continue to address service, design, and engineering issues and extend maintenance to all products for the duration of their use.





# ADAPT2

Tables



# Adapt2 Tables

Adapt2 Table Collection offers a wide range of shapes, sizes and materials to provide multiple options for library and university designs. Support various and changing community needs with the Adapt2 Table Collection.



## PRODUCT LINE

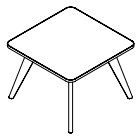

- Square Table**
- 42" W x 42"D x 30"H
  - 48" W x 48"D x 30"H



- Soft Square Table**
- 42" W x 42"D x 30"H
  - 48" W x 48"D x 30"H



- Boat Table**
- Length - 60", 72", 84", 96"
  - Depth - 36", 42", 48"
  - Height - 30"

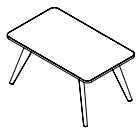

- Rectangle Table**
- Length - 60", 72", 84", 96"
  - Depth - 36", 42", 48"
  - Height - 30"

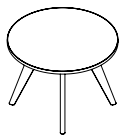

- Circle Table**
- 42" W x 42"D x 30"H
  - 48" W x 48"D x 30"H

## SPECIFICATIONS

### Worksurface

Standard Laminate Options

### Electrical

On-Surface - 4 Port (2 Power & 2 USB-A +C)

### Base Finishes

Wood Standard - Natural Maple

Metal Standard - Black Wrinkle, White, Metallic Silver

### Powdercoats

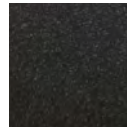

Black Wrinkle



White



Metallic Silver

**AGATI**  
FURNITURE

Call 312.829.1977 or visit us at [agati.com](http://agati.com)

# ADAPT2

Workstations



## ADAPT2 Your Space

Adapt2 provides the flexibility to reconfigure your space, at any time, without any hassle. Choose from the Trapezoid, Rectangle and Arrow Wrap tabletop shapes. Arrange tables in various configurations for group work, or add acoustic panels for individual privacy. Easily move Adapt2 from stand-alone workstations to various groupings as frequently as you like -our tested durability and engineered mobility ensures they remain strong for years of public use.

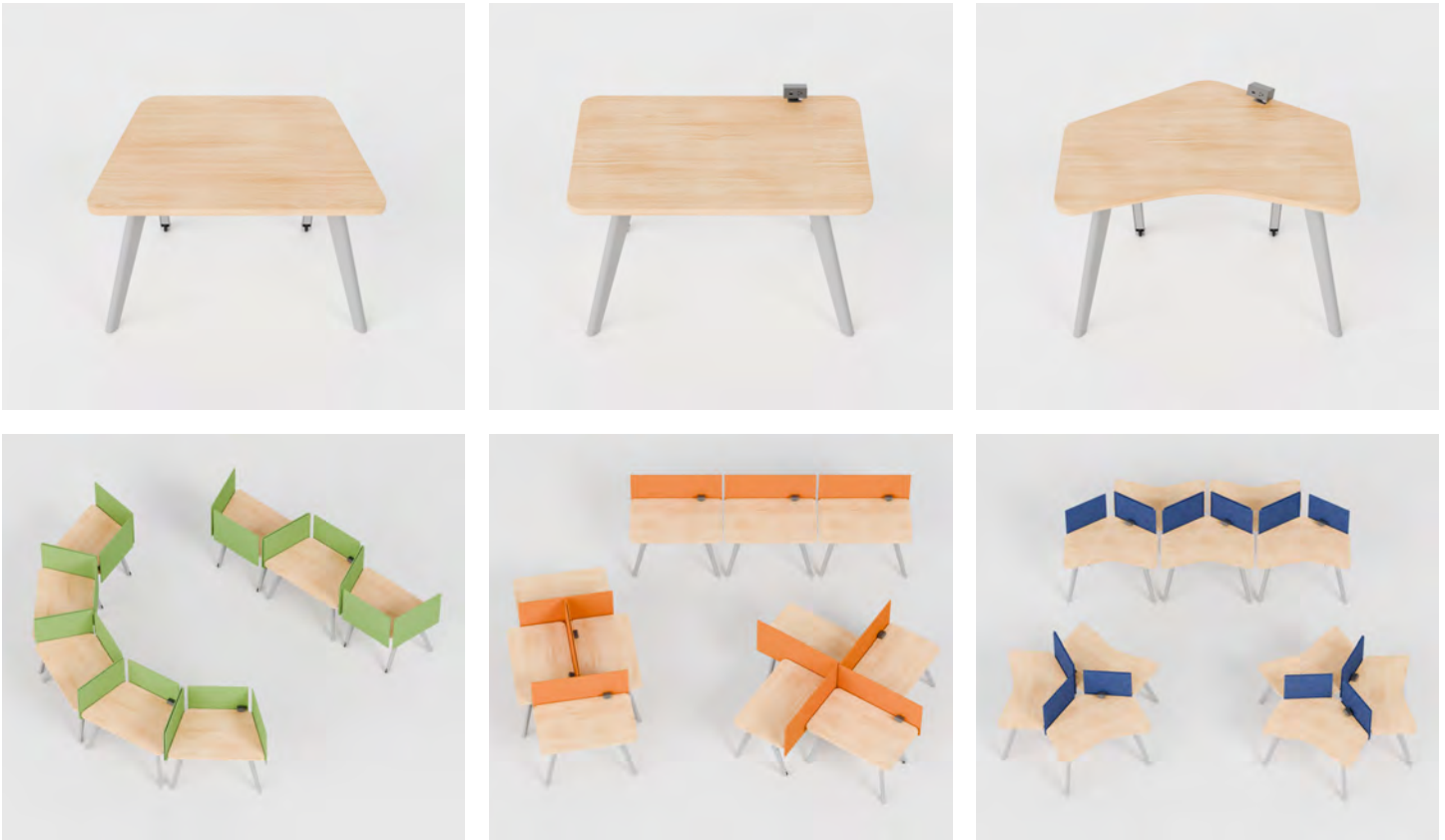

## Flexible Power

Each Adapt2 Workstation includes a strategic wire management solution. On-surface power gives users easy access to connect, while the power strip underneath the worksurface offers a convenient extension. Two cable management spools neatly wrap any excess cord length. Legs are engineered with tracks to encase and precisely route cord down to floor.

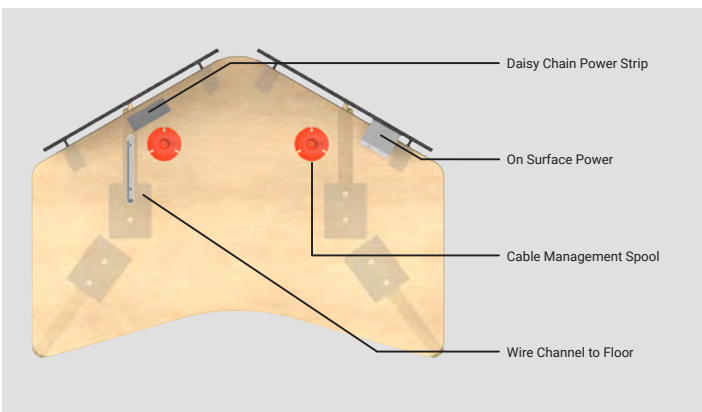



## Legs

Select from metal or solid maple legs. With a focus on extreme durability, Adapt2 legs are engineered for frequent movement. Wheels on back two legs facilitate easy rolling when front two legs are lifted. Adapt2 is deliberately designed to stay steadfast through weight distribution when set in place.

## PRODUCT LINE



**Adapt Arrow Wrap Workstation**  
• 48" W x 35"D x 30"H



**Adapt Arrow Wrap Workstation**  
• 48" W x 35"D x 30"H  
• Two Acoustical Panels



**Adapt Rectangle Workstation**  
• 48" W x 30"D x 30"H



**Adapt Rectangle Workstation**  
• 48" W x 30"D x 30"H  
• Acoustical Panel



**Adapt Trapezoid Workstation**  
• 48" W x 30"D x 30"H



**Adapt Trapezoid Workstation**  
• 48" W x 30"D x 30"H  
• Acoustical Panel

## SPECIFICATIONS

### Worksurface

Standard Laminate Options

### Electrical

On-Surface (1 Power & 2 Port USB-A +C)

### Base Finishes

Wood Standard - Natural Maple

Metal Standard - Black Wrinkle, White, Metallic Silver

### Powdercoats

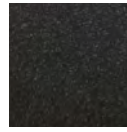

Black Wrinkle

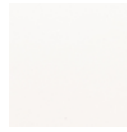

White



Metallic Silver

### Acoustical Paneling

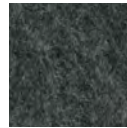

Slate



Tar

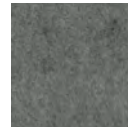

Fossil

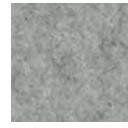

Greige



Linen

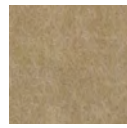

Ecu

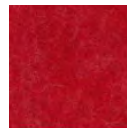

Ochre



Grass



Cobalt



Sky



Mandarin

**AGATI**  
FURNITURE

Call 312.829.1977 or visit us at [agati.com](http://agati.com)



# BLOCKS

Display Shelving



# Architectural Displays

Blocks introduces a fresh perspective on display shelving with its tiered structure, offering an architectural aesthetic that beautifully showcases books stored in various configurations. Whether you're placing books in spine-out or a displaying a new collection, Blocks provides ample shelves to suit your needs.



## PRODUCT LINE

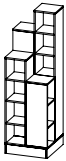

**Blocks 72" High**  
• 24"W x 24"D x 72"H

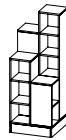

**Blocks 66" High**  
• 24"W x 24"D x 66"H

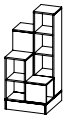

**Blocks 54" High**  
• 24"W x 24"D x 54"H

## SPECIFICATIONS

### Plastic Laminate Options

Standard Plastic Laminates

### Base Options

Hidden Non-Locking Casters  
Levelers

# BRICKS

Display Shelving

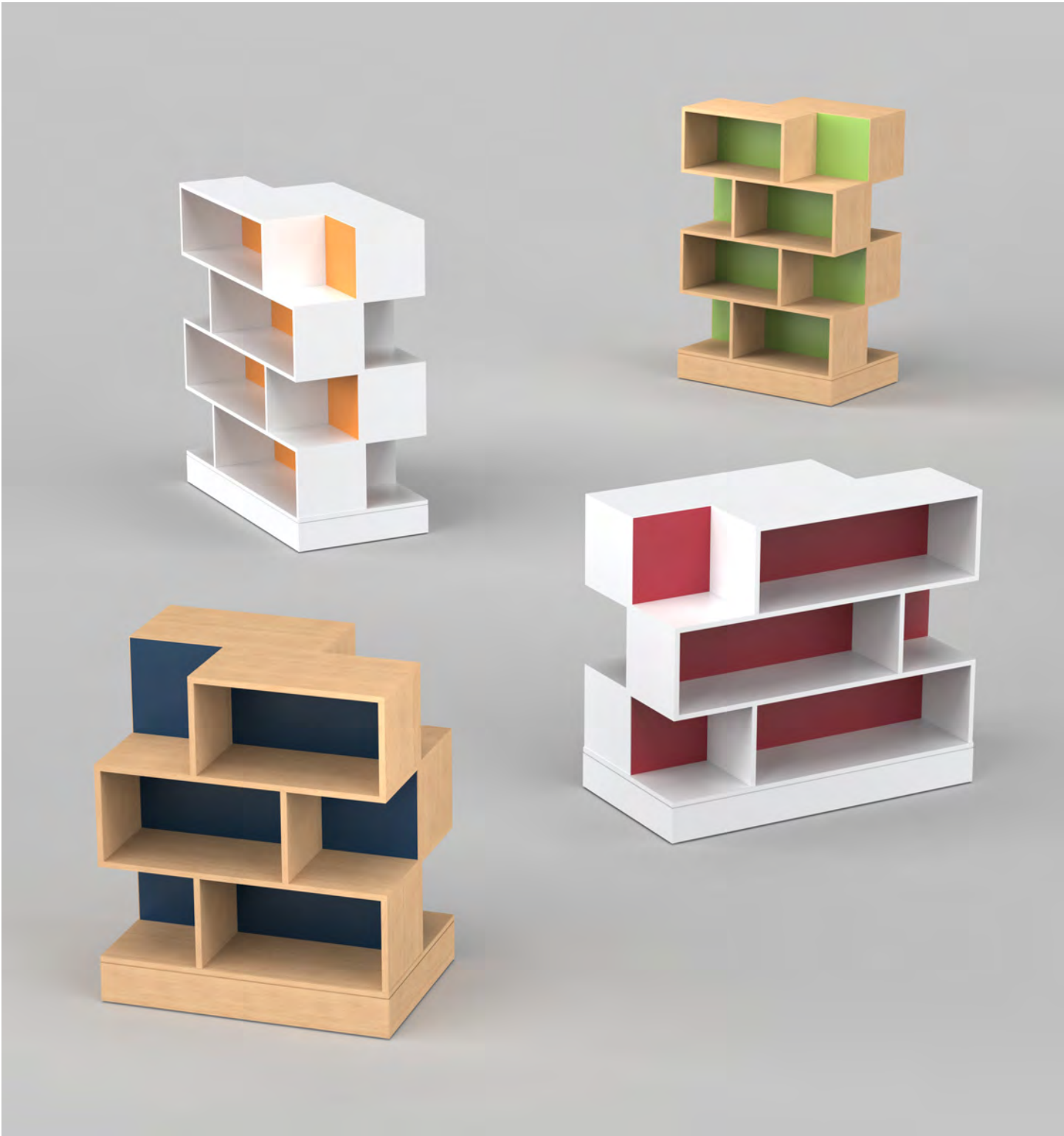



# Architectural Displays

Bricks presents a novel approach to display shelving, characterized by its architectural aesthetic of vertically stacked bricks. This design provides ample space for showcasing books, complemented by side nooks ideal for displaying items or new additions to your collection. And the offer for two tone adds flare to the books being displayed inside, along with adding color to your library.

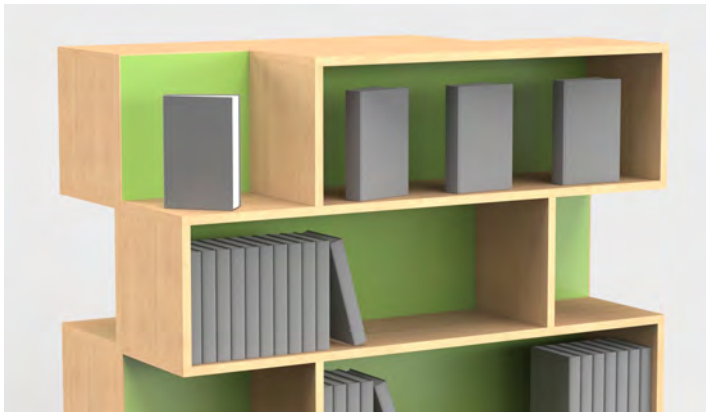

## PRODUCT LINE

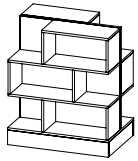

**Bricks 36"**  
• 36" W x 24"D x 42"H

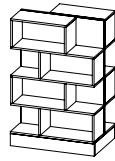

**Bricks 36"**  
• 36" W x 24"D x 54"H

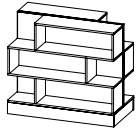

**Bricks 48"**  
• 48" W x 24"D x 42"H

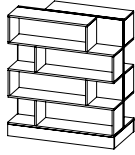

**Bricks 48"**  
• 48" W x 24"D x 54"H

## SPECIFICATIONS

### Plastic Laminate Options

Standard Plastic Laminates

### Base Options

Hidden Non-Locking Casters  
Levelers

# ETTA



At last, the Etta Collection from AGATI Furniture. AGATI designs from a higher perspective, one which utilizes key consumer insights in engineering to increase public furniture standards. The Etta collection does this by incorporating a light Modernist aesthetic into traditional furniture.

Power options are available for tables and casters available for chairs, bringing mobility and power to modern environments.

**AGATI**  
FURNITURE

[www.agati.com](http://www.agati.com)

# ETTA



\*Available with power



## Seating

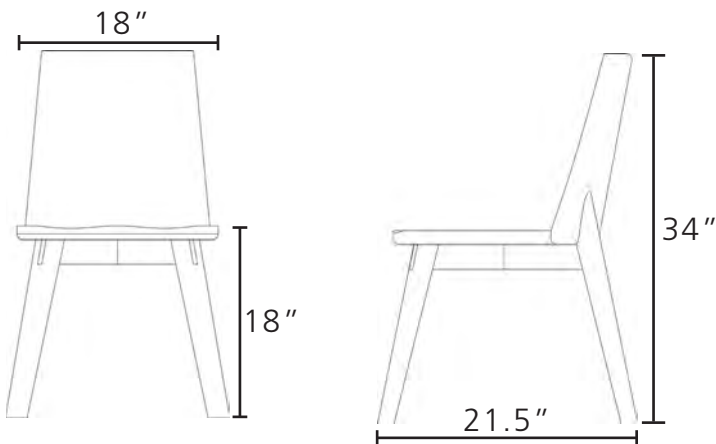

## Table

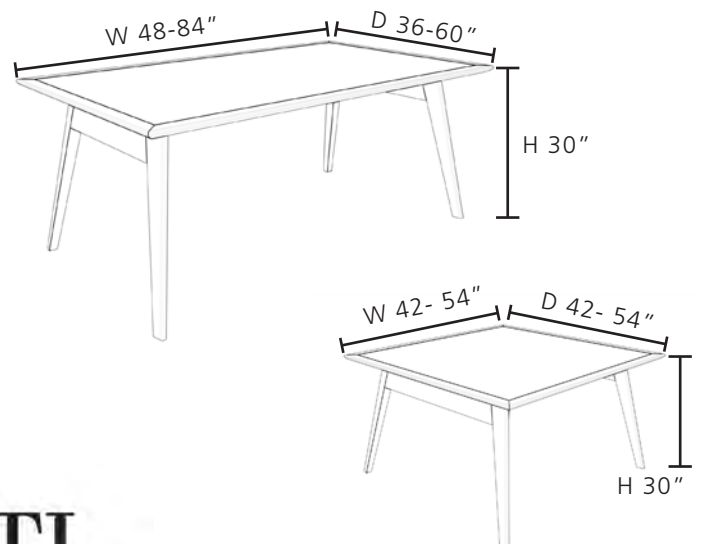



## POD



With its curvy lines and stylish architecture, POD undoubtedly stands out in any environment.

A contemporary take on the study carrel, the POD is designed to create total comfort for individuals wanting their own private study haven. Enter POD at the side for an experience completely unique to the world of library furniture. The back-covering, upholstered curved panel and power options ensure total focus on tasks while allowing users to maintain their connection to the surrounding open environment.

Aesthetics and functionality blend seamlessly in the new POD, bringing the modern study haven to a new generation of users.

# POD



## Specifications

- Upholstered surround (fabric must be railroaded)
- Upholstered Hampton seating
- Standard plastic laminate work surface and side shelf with PVC edgeband
- Clear anodized aluminum legs
- Power options: plug set or 4trak (hard wired). Both include 1 power & 1 dual port USB pop up.

\*Fabrics must be tested for approval

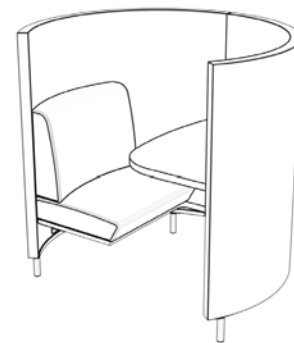

52dia 49h 19sh

**AGATI**  
FURNITURE

[www.agati.com](http://www.agati.com)

## POD DUO



Because two heads are better than one, the POD Duo provides comfortable accommodations for a pair who need a sanctuary-like workspace.

The POD Duo creates a small and stylish meeting room right in the middle of your main floor without the cost of building permanent walls.

Privacy is an organic design element with sound-absorbing upholstered panels that are high enough to block visual distractions but do not disrupt the room's sightlines. With space for two, POD Duo is ideal for one-on-one tutoring, interview training, or pair group activities.



**AGATI**  
FURNITURE



# POD DUO



## Specifications

- \*Upholstered Surround (fabric must be railroaded)
- \*Upholstered Hampton Seating
- \*Standard plastic laminate work surface and side shelf with PVC edgeband
- \*Clear anodized aluminum legs
- \*Power options: plug set or 4trak (hard wired). Both include 2 power & 1 dual port USB pop up.

*\*FABRICS MUST BE TESTED FOR APPROVAL*

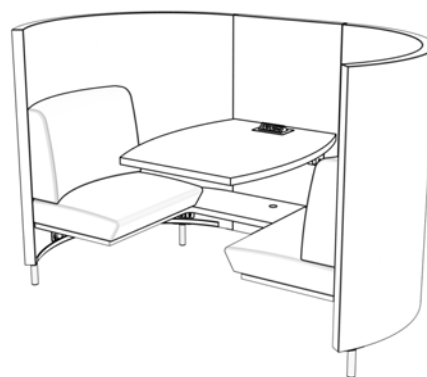

76w 41d 49h 19sh

**AGATI**  
FURNITURE

[www.agati.com](http://www.agati.com)

# NOOK



Nook expands the Hampton banquette family by offering the same classic-yet-modern style in a private workspace. Available in several different configurations, Nook's flexibility can be adapted for just about any area where focused study space is a must.

The hallmark material quality and seating ergonomics found in the Hampton line carries over into the Nook's design; it can stand alone or create a consistent aesthetic when surrounded by its "siblings" from the Hampton family.



**AGATI**  
FURNITURE

[www.agati.com](http://www.agati.com)



# NOOK

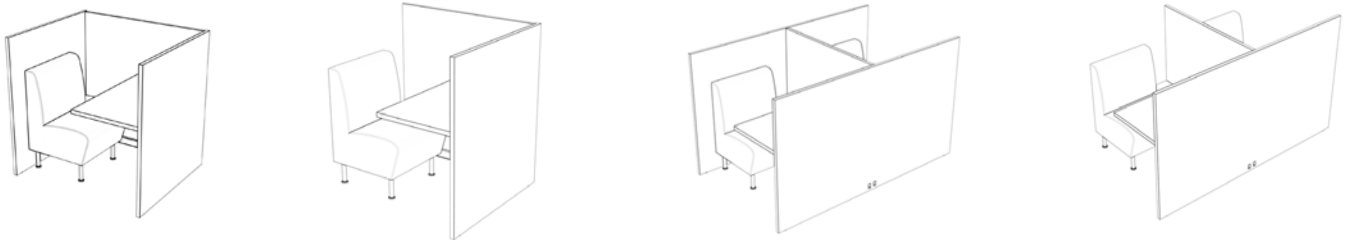

## Specifications

- Wood veneer or plastic laminate surround
- Upholstered Hampton seating
- Standard plastic laminate work surface and side shelf with PVC edgeband
- Clear anodized aluminum legs
- Power option includes 1 power & 1 dual port USB pop up at work surface, plug set or 4trak (hardwired).

*\*Fabrics must be tested for approval*

## Dimensions

Starter width: 49"  
Adder width: 48"

Single faced depth: 42"

Double faced depth: 84"

Overall height: 48"

Seat height: 19"

**AGATI**  
FURNITURE

# NOOK DUO



# NOOK DUO



## Specifications

Surrounds: Veneer or Plastic Laminate

Upholstered Hampton Seating

Standard plastic laminate work surface and side shelf with PVC edgeband

Clear anodized aluminum legs

Power options: plug set or 4trak (hardwired). Both include 2 power & 1 dual port USB pop up.

*\*Fabrics must be tested for approval*

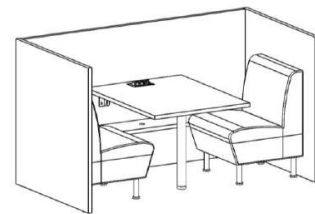

**AGATI**  
FURNITURE

[www.agati.com](http://www.agati.com)



POD Jr



**AGATI**  
FURNITURE

## REDUCE DISTRACTIONS

The enclosed panels on the POD Jr ensure immediate visual stimulation is minimized, providing a calm area to focus and enabling learning to take place while dampening sound.

## SENSE OF SECURITY

The enclosed back also provides a sense of space and security, which can be comforting and supportive for all children.

Cleanable acoustical paneling & acrylic



Ample workspace

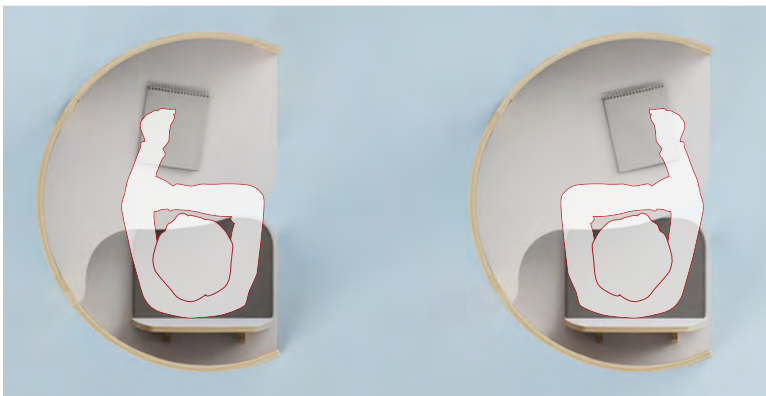
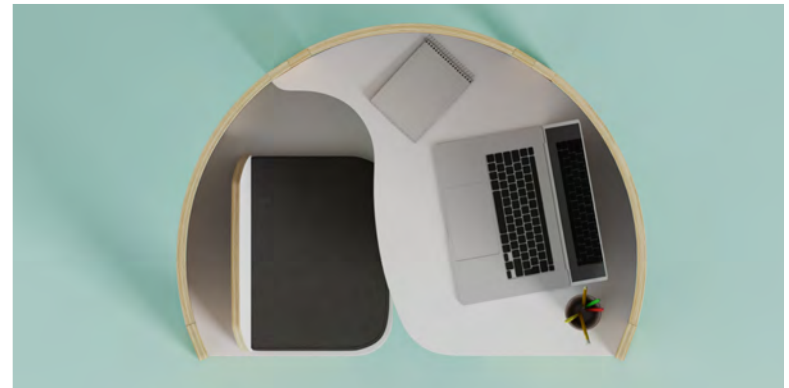

Designed for left and right handed users

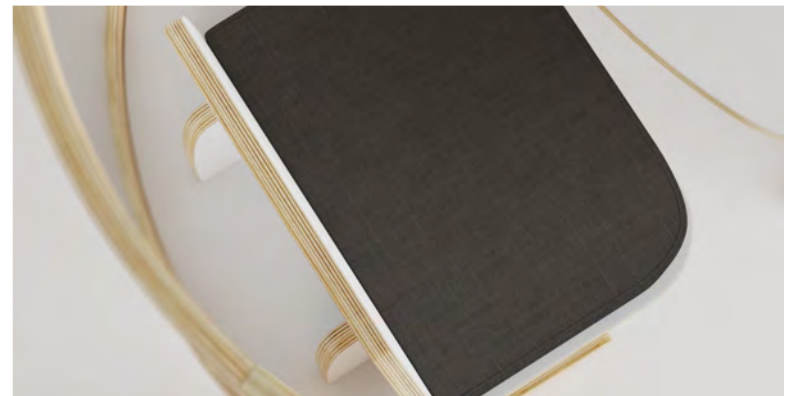

Reovable and replaceable seat cushion

**AGATI**  
FURNITURE

# Pod Jr

Modeled after the revolutionary original design of the POD Study Carrel for libraries and public spaces, our team is eager to introduce the POD Jr, a specialized adaptation of the POD design for young learners at home.

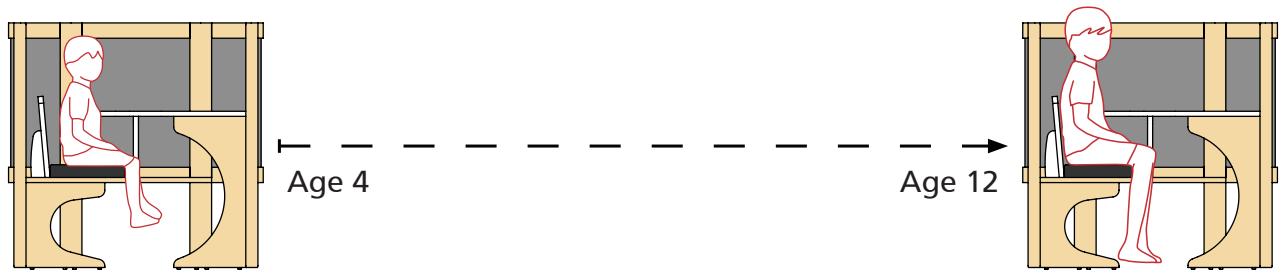

**POD JR - FELT**

37.5"W x 27"D x 36"H  
16"Seat Height



**POD JR - ACRYLIC**

37.5"W x 27"D x 36"H  
16"Seat Height



**POD JR - FELT  
- No Seat**

37.5"W x 27"D x 36"H  
14"Seat Height



**POD JR - ACRYLIC  
- No Seat**

37.5"W x 27"D x 36"H  
14"Seat Height





# POWER BAR/TABLE COLLECTION

Available options:

- POWER TABLE
- POWER BAR
- SKINNY POWER BAR
- POWER BAR WITH ADA EXTENSION



*Help your patrons recharge.*

AGATI's Power Bar/Table Collection upgrades public spaces by providing functionality for users in a clean, minimal design. Combine pieces from the collection for a cohesive aesthetic.

Expert craftsmanship, tested engineering, and durable materials ensure the Power Bar/Table Collection withstands the test of time.

Designed and made in the USA.



**AGATI**  
FURNITURE

## POWER BAR



As one of the first to engineer and build Power Bars for the busiest of airports, the AGATI Power Bar is a tested favorite.

A charging station with power outlets that line the edge of the work surface, the Power Bar is as functional as it is stylish.

Wire management is contained behind the side panels, so all you see is a modern and inviting space.



**AGATI**  
FURNITURE

[www.agati.com](http://www.agati.com)



# POWER BAR

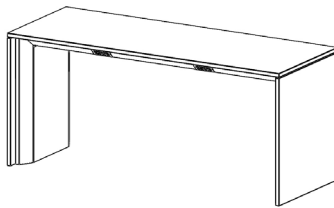
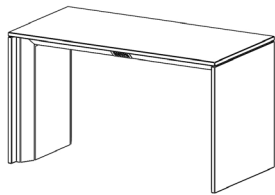

## Specifications

- Top & Side Panels: Plastic Laminate or Stone
- Base: Stainless Steel or Powder Coat
- 72" Wide Includes 1 Electrical unit per side  
96" Wide Includes 2 Electrical units per side  
120" Wide Includes 3 Electrical units per side
- Each electrical unit includes 2 Power and 1 USB A+C port

## Dimensions

Width: 72", 96", or 120"  
Depth: 36", or 30"  
Height: 42"

\*Custom options available upon request.

## SKINNY POWER BAR



Maximize usable space with the Skinny Power Bar along windows, walls, or in the center of a room.

Pair with stools, or use as a walk up charging counter.

Outlets along the apron rail leave the work surface free of clutter.

Choose mounted screen and modesty panel option to create privacy in an open space.



# SKINNY POWER BAR



## Specifications

- With or without mounted screen and modesty panel (all one piece)
- Top & Side Panels: Plastic Laminate or Stone  
Base: Stainless Steel or Powder Coat
- 72" Wide Includes 1 Electrical unit per side  
96" Wide Includes 2 Electrical units per side  
120" Wide Includes 3 Electrical units per side
- Each electrical unit includes 2 Power and 1 USB A+C port
- Single-sided power is available upon request.  
Single-sided power is standard when modesty panel is specified

## Dimensions

Width: 72", 96", or 120"  
Depth: 18", or 24"  
Height: 42"

Note: Skinny Bar needs to be bolted down at both ends

## POWER TABLE



AGATI's Power Table is striking as a stand alone piece, with it's strong, streamlined design.

Collaboration tables give users community space to recharge and work together or alone.

Pair with Power Bars to give users alternate height options while maintaining a cohesive aesthetic.

Outlets on the work surface leave space underneath clear for users when seated at table height.

Choose from a wide array of durable materials to compliment your design.



**AGATI**  
FURNITURE

[www.agati.com](http://www.agati.com)

# POWER TABLE

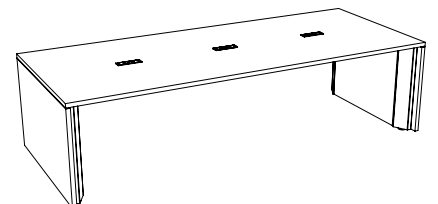
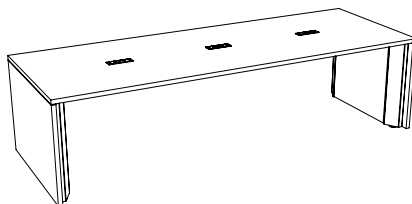
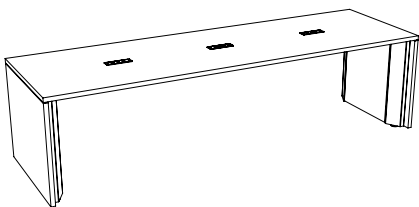
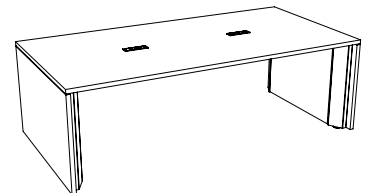
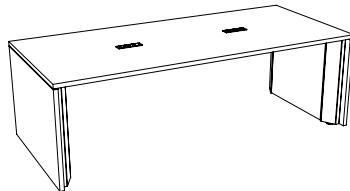
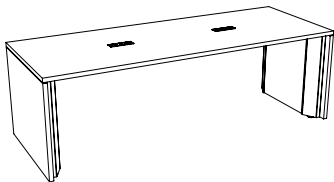
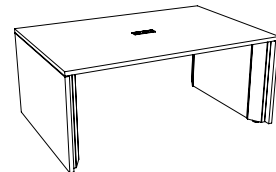
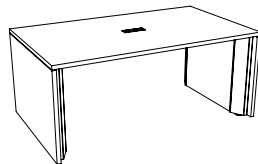
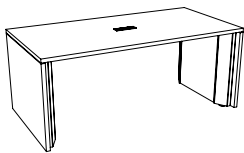

## Specifications

- Top & Side Panels: Plastic Laminate or Stone
- Base: Stainless Steel or Powder Coat
- 72" Wide Includes 1 Electrical unit on tabletop  
96" Wide Includes 2 Electrical units on tabletop  
120" Wide Includes 3 Electrical units on tabletop
- Each electrical unit includes 2 Power and 1 USB A+C port

## Dimensions

Width: 72", 96", or 120"  
Depth: 36", 42", or 48"  
Height: 30"

- Can meet ADA Standards

**AGATI**  
FURNITURE

## POWER BAR - ADA EXTENSION



ADA compliant, this extension option changes the Power Bar to a two-height bar, making it more universally accessible.

Electrical unit is added to side panel of the standard height Power Bar.

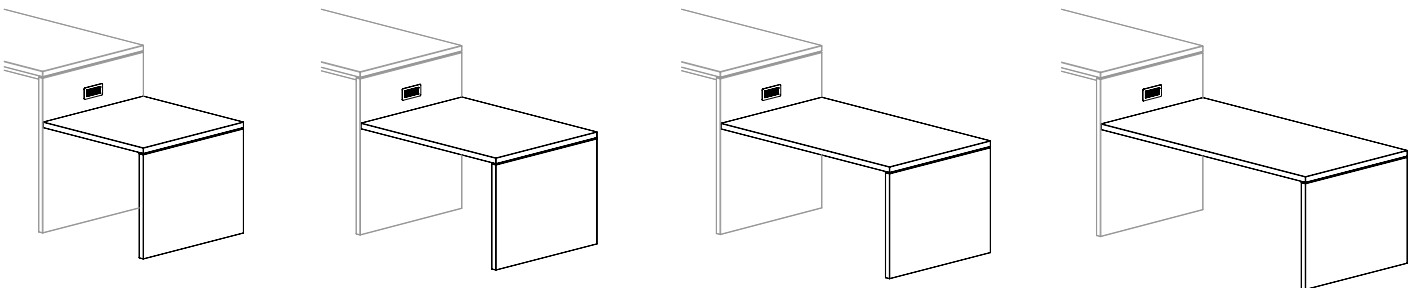

### Specifications

- Top & Side Panels: Plastic Laminate or Stone
- Base: Stainless Steel or Powder Coat
- Each electrical unit includes 2 Power and 1 USB A+C port

### Dimensions

Width: 36", 48", 60" or 72"  
Depth: 30" or 36"  
Height: 30"



**ORB**  
Lounge



# Orb Lounge Chair

The Orb Lounge chair supports guests like a baseball glove. Enjoy the protection of wrap-around arms and a generous seat. Orb holds and supports users, creating that sense of security and comfort, in a public space. Extremely durable, the Orb Lounge chair is built for public use.

## Maintenance Simplified

The Orb Lounge chair was designed to give you the opportunity to remove the back and seat. The ability to easily change the back or seat sections provides ease of care for long term maintenance, increasing the longevity of your furniture collection.



Choose from Disc-Base or X-Base, depending on the needs of your space.

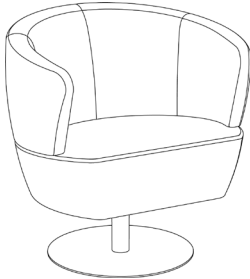

**Disc Base Orb**  
18SH 30"W x 30"D x 30H  
Free Swivel



**X - Base Orb**  
18SH 30"W x 30"D x 30H  
Free Swivel







Stationary seating combinations in organic shapes provide new options in space planning. While the coziness of wrap-around arms in the lounge chair gives travelers a feeling of security in a public space. Guests have everything they need for a pleasant waiting experience -access to usb and power to charge their devices, a stone tabletop for their belongings and coffee, and roomy personal space. Select from a three-person or four-person seating and table combination.

**The Orb Cluster has been designed to give users:**

- Comfortable lounge seating experience with the security of wrap-around arms
- Access to usb/power at fingertips
- Personal surface space for their belongings
- Staggered sight lines and generous physical space for independent personal bubbles.



# ORB CLUSTER

Power recepticals for each user by their own seat.

The cluster design allows for wire management that comes down to one point on the floor.

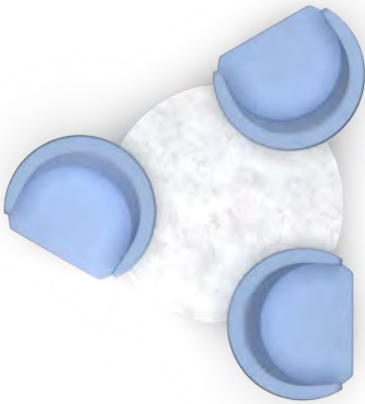

**3 Cluster**  
78"W x 73"D x 31"H

3 Power Recepticals

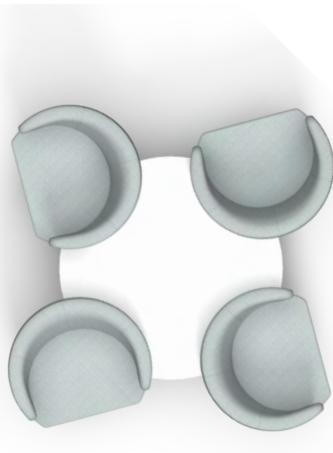

**4 Cluster**  
87"W x 87"D x 31"H

4 Power Recepticals



VERA



**AGATI**  
FURNITURE



PASS THROUGH FOR EASY CLEANABILITY



WIRE MANAGEMENT CHANNELS ATTACH TO FRAME

## CONNECTING TABLES

THIS SEMI-MODULAR LOUNGE COLLECTION PROVIDES A VARIETY OF SEATING CONFIGURATIONS AND THE ABILITY TO MAKE LONG RUNS OF SINGLE SEATS, DOUBLE SEATS, AND BENCHES

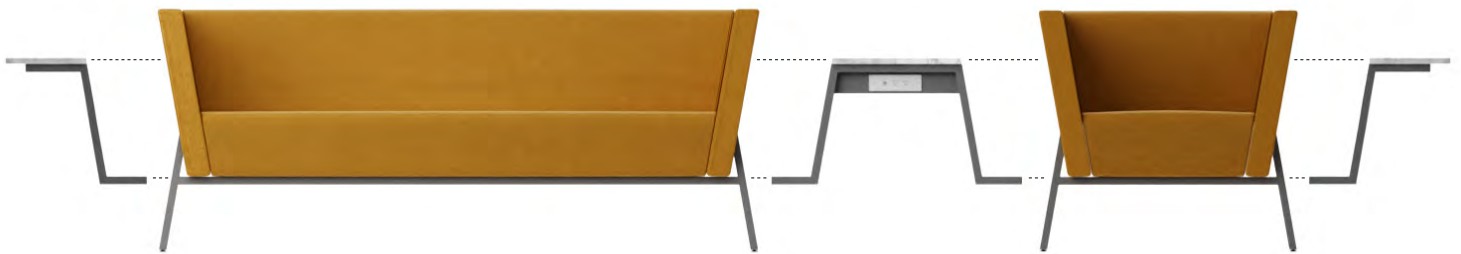

## ELECTRICAL

POWER IS DISTRIBUTED THROUGH WIRE MANAGEMENT CHANNELS AND ALLOW FOR DROP TO FLOOR AT YOUR FLOORBOX LOCATION







# The Vera Lounge Collection

The Vera Collection offers a contemporary, angular design, along with the comfort of wrap-around arms. This semi-modular collection provides a variety a seating configurations, seamless power integration, easy cleanability, and easy maintenance.

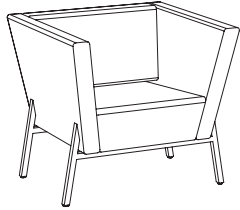

## LOUNGE CHAIR

32"W x 30"D x 30"H  
18"Seat Height

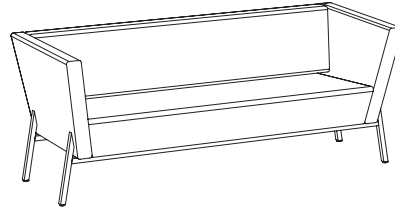

## SETTEE

74"W x 30"D x 30"H  
18"Seat Height

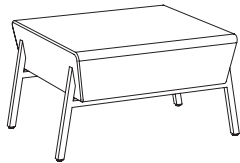

## OTTOMAN

32"W x 30"D x 18"H  
18"Seat Height

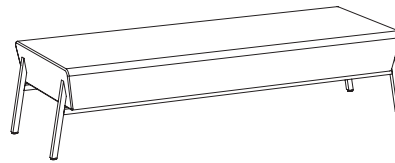

## BENCH

74"W x 30"D x 18"H  
18"Seat Height

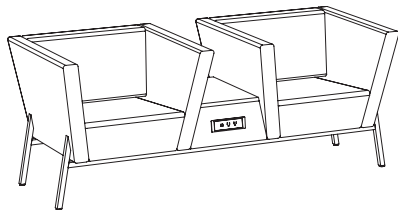

## DOUBLE LOUNGE CHAIR WITH POWER TABLE

74"W x 30"D x 30"H  
18"Seat Height

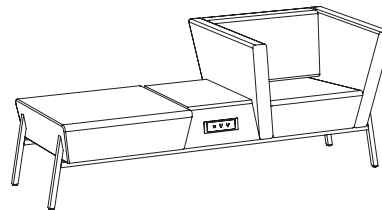

## LOUNGE CHAIR WITH OTTOMAN WITH POWER TABLE RF

74"W x 30"D x 30"H  
18"Seat Height

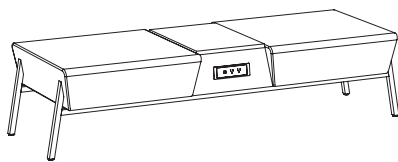

## DOUBLE OTTOMAN WITH POWER TABLE

74"W x 30"D x 18"H  
18"Seat Height

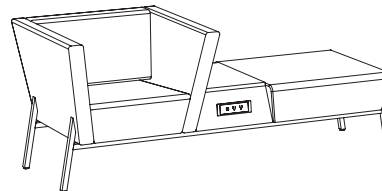

## LOUNGE CHAIR WITH OTTOMAN WITH POWER TABLE LF

74"W x 30"D x 30"H  
18"Seat Height

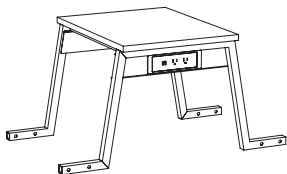

## CONNECTION TABLE

16"W x 20 1/4"D  
24" or 18" Above Finished Floor

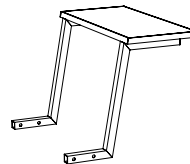

## SIDE TABLE

10"W x 20 1/4"D  
24" or 18" Above Finished Floor



## FRAMEWORK



We often see libraries face a consistent problem: They simply don't have enough private study rooms or meeting space for their students and patrons.

And the issue makes sense. Many libraries can't devote much space to private rooms because they have to address such a diverse set of needs. Group work. Individual study. Children's space. Physical space for books. Meeting space. Areas for teens. Resources for seniors. Computer stations. Classrooms. And the list goes on.

In some academic libraries, the issue gets even more complicated. Many of these libraries were built years ago, and the growth of the university has outpaced the expansion of the library, and resources like study rooms never go unoccupied.

And if you take into account the global health crisis, space issues in libraries get even more complex. Now, we have to make our limited space stretch even further, be intentional about adjusting the flow of our facility, and figure out creative ways to promote social distancing among patrons.

This is where FrameWork, our newest addition to the Agati lineup, comes in with a simple and innovative approach to solving space issues.



FrameWork Curve



FrameWork Straight





# FRAMEWORK



## Metal Finish

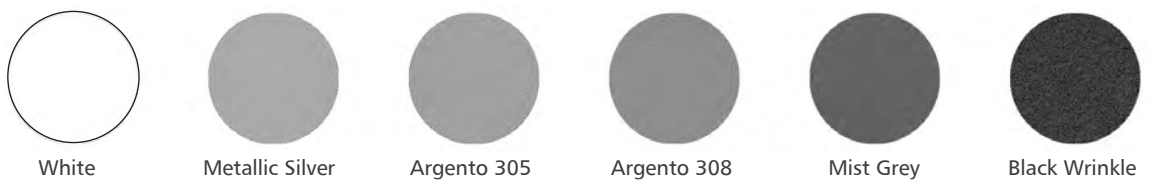

## Felt Colors



Think of the possibilities



# FRAMEWORK

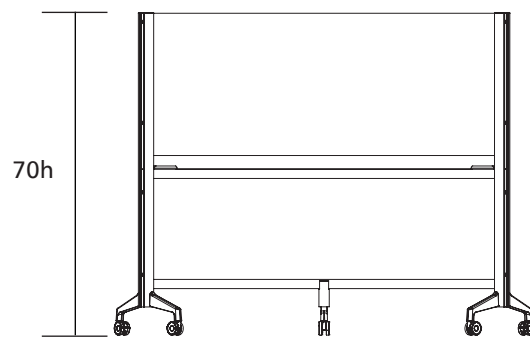
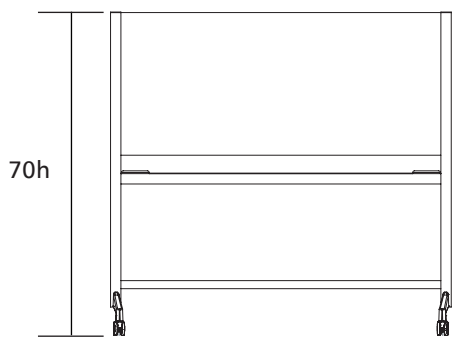
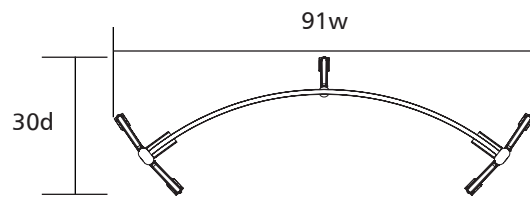
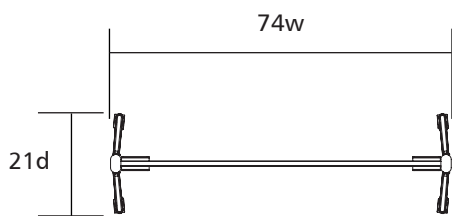
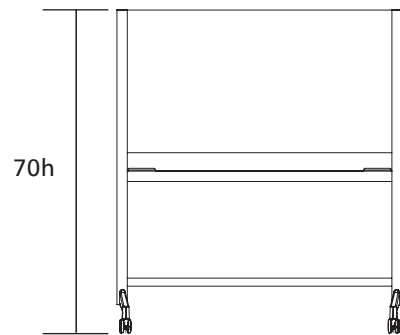
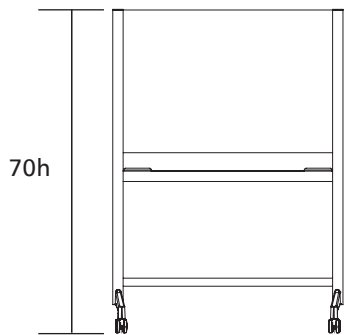
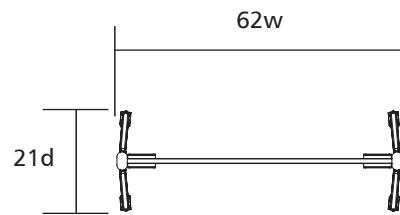
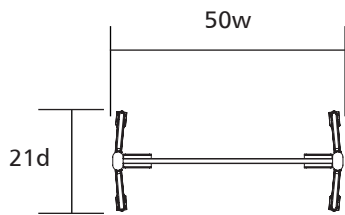

MANIFEST





Six person workstation with 3Form dividers.

Built upon the same institutional standards that have become an AGATI signature, the Manifest features a durable, cantilevered table top. Behind its modern design, Manifest is solidly constructed to withstand the rigors of everyday use allowing Manifest to effortlessly transition between markets.



Three person pod with 3Form dividers.



Manifest 6 with 3Form dividers.





Six person zig-zag workstation with 3Form dividers.

## MANIFEST Desking System

### Smart, simple, workspace solutions.

The Manifest Desking System is AGATI's newest and most contemporary desking system built upon the idea of affordable collaboration and configurability.

Designed in response to a need for a more collaborative work solution, Manifest is lighter in scale and design making it easy to configure to groups of all sizes and work needs. Optional returns or mobile tables allow for more seamless communication, integrated into standard configurations that include a straight bench, 120-degree pod or the aesthetically pleasing "zigzag" station.

Easy to set up and install, the Manifest supports wire management in an organized wire management basket that allows dual sided access to electrical. Accessories include panel dividers in 3Form, wood, laminate or tack boards, as well as optional shelving and pedestals. Work surface tops are also available in wood or laminate. Visit [www.agati.com](http://www.agati.com) to view more options.



Six person zig-zag workstation with 3Form dividers.



AGATI is defined by versatility. Designs combine a unique blend of aesthetics and engineering, distinguished by their eclectic styles. Inspired by the need for furniture that is both timeless and universal, AGATI is committed to design and engineering of each and every piece.

Furniture built to last a lifetime means investing in the future. AGATI is dedicated to implementing sound environmental practices such as utilizing domestic reforested lumber, as well as reusable packaging materials. AGATI believes in helping preserve resources at no expense to the integrity of the product or the satisfaction of the customer.

Celebrated for its design. Chosen for its quality.



**AGATI**

1219 W Lake Street Chicago, Illinois 60607 T 312.829.1977 F 312.829.8249 [www.agati.com](http://www.agati.com)

©2013 Agati, Chicago, Illinois Printed in USA 3/13\_2M





# The Vista Modular Bench Collection

Vista Modular Benches provide contemporary soft seating solutions. Create custom bench configurations by connecting cushioned seats and charging tables with stone tops. Mix and match seating segments, to create the length and shape that work for your space plan. Or, use the elegant standalone benches in your lounge area or touchdown space. All are on sleek 5" metal legs for easy cleaning, maintenance, and of course, style. With 10 segments to choose from, we can help you design the perfect seating for your facility.

## Add-ons



24" Add-on  
24"W x 24"D x 19"H

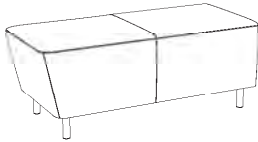

48" Add-on  
48"W x 24"D x 19"H

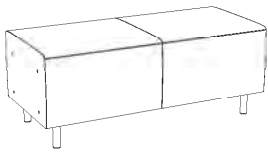

48" Middle  
48"W x 24"D x 19"H

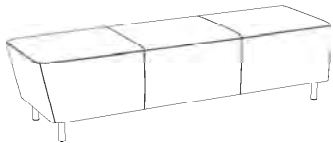

72" Add-on  
72"W x 24"D x 19"H



48" Table  
24"W x 22"D x 12"H

## Standalone

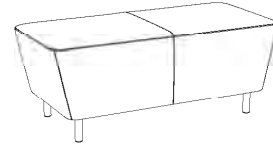

48" Bench  
48"W x 24"D x 19"H

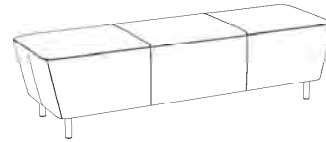

72" Bench  
72"W x 24"D x 19"H

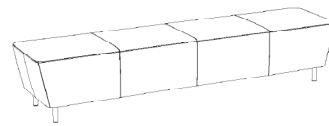

96" Bench  
96"W x 24"D x 19"H



24" Table  
24"W x 22"D x 12"H



ELEMENTS  
MEDIA





Technology your way. Choose from one laptop connection or multiple laptop connections. Collaborate as a group, as well as with those in remote locations.



Pair the Hampton Banquette with Elements Media for comfortable, supportive seating that accommodates groups of multiple sizes. For additional seating and workspace, add a back shelf and AGATI Jet or Sensi stools.





## ELEMENTS MEDIA

Elements Media features AGATI's Hampton Seating, which answers the call for effective, yet creative use of space. Accommodating groups of all sizes, both the round and straight Hampton banquettes can be used with Elements Media. Add optional surrounds covered in fabric or sleek veneers for ultimate privacy.

Technology is an ever changing landscape; AGATI adapts its furniture to meet these changes head on while maintaining the integrity of its original design.

Visit [www.agati.com](http://www.agati.com) to see more.



The optional switching system allows multiple users to share access with the touch of a button.





AGATI is defined by versatility. Designs combine a unique blend of aesthetics and engineering. Inspired by the need for furniture that is both timeless and universal, AGATI is committed to the design and engineering of each and every piece.

Furniture built to last a lifetime means investing in the future. AGATI is dedicated to implementing sound environmental practices such as utilizing domestic reforested lumber, as well as reusable packaging materials. AGATI believes in helping preserve resources at no expense to the integrity of the product or the satisfaction of the customer.

Celebrated for its design. Chosen for its quality.



**AGATI**

1219 W Lake Street Chicago, Illinois 60607 T 312.829.1977 F 312.829.8249 [www.agati.com](http://www.agati.com)

©2014 AGATI, Chicago, Illinois

ANTRIM





Antrim Table in maple with inset Marmoleum top and Stardust Silver finish.

Knife Edge Profile



Square Edge Profile



Heavy Edge Profile



Updated Leveler



Antrim Table in maple, Antrim Chairs with casters.

Antrim Carrel in maple with wire chase leg option, below left. Antrim Stacking Chairs, below right.







Columbia University Health Sciences Library, Hammer Teaching & Learning Center

## ANTRIM Collection

The Antrim Collection's distinctive "floating" work surface features a standard upswept knife edge profile, as well as optional square and heavy edge profiles. The cold-rolled steel base is sealed with a durable, eco-friendly powder coat finish. The Antrim Collection is available in a wide variety of materials and finishes including wood veneers, plastic laminates and Marmoleum® insets.

Technology management solutions include power and data connections with wirec hase leg enclosures. Paired with innovative lighting, the Antrim Collection is designed to enhance its environment, while fulfilling modern technology needs. The collection includes study tables, carrels, occasional tables, chairs, benches and endpanels. Visit [www.agati.com](http://www.agati.com) to see more.



Antrim Bench



Oak Park Public Library,  
Open Book Cafe





The City College of New York, Spitzer School of Architecture.



Side Chair



Study Table



Occasional Table

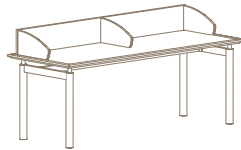
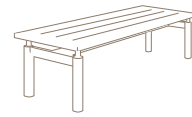

table Carrel



Bench



End Panel

AGATI is defined by versatility. Designs combine a unique blend of aesthetics and engineering, distinguished by their eclectic styles. Inspired by the need for furniture that is both timeless and universal, AGATI is committed to the design and engineering of each and every piece.

Furniture built to last a lifetime means investing in the future. AGATI is dedicated to implementing sound environmental practices such as utilizing domestic reforested lumber, as well as reusable packaging materials. AGATI believes in helping preserve resources at no expense to the integrity of the product or the satisfaction of the customer.

Celebrated for its design. Chosen for its quality.



# AGATI

1219 W Lake Street Chicago, Illinois 60607 T 312.829.1977 F 312.829.8249 [www.agati.com](http://www.agati.com)

©2010 AGATI, Chicago, Illinois Printed in USA 11/10\_3M



ROLAND



**AGATI**  
FURNITURE



Roland Carrel with shelf and lighting options.



Roland Round Study Table with maple top.



Round Study Table with cherry top and lighting option.



Roland Round Bench with upholstered seat.



Roland Bench with upholstered seats and inset granite table.



Roland Occasional Table with granite top.



Roland Conference Table shown with data port option.

## ROLAND Collection

A modern display of wood and metal, the Roland Collection epitomizes today's forward, contemporary design. The collection maintains a striking presence with its stylish, modern design. Stainless steel bases support the Roland's floating work surface for an uncluttered, clean profile. Tables feature an inset wood veneer top with a solid wood square edge. The Roland's thin straight leg and apron rails add to its modest and fresh appeal.

The Roland Collection answers the call for today's functional needs in everyday, modern settings. Well suited for contemporary spaces, the Roland can accommodate today's technological needs. Add glass or wood dividers for more institutional environments. The Roland Collection includes study tables, occasional tables, carrels, benches and end panels. Visit [www.agati.com](http://www.agati.com) to see more.



ROLAND  
COURTROOM



Judges Table



Courtroom Podium



Witness Stand



Counsel Table



# The Roland Courtroom Collection

The Roland Collection Courtroom Suite includes Judge's Bench, Lectern, two Witness Stands, and two Attorney Tables. AGATI's Roland Collection maintains a striking presence with its stainless steel bases and stylish, modern design.

---

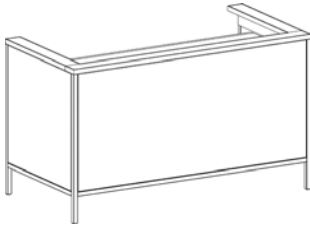

**Judges Bench**  
60-84"W 36"D 42"H  
36"H Worksurface

Power Optional

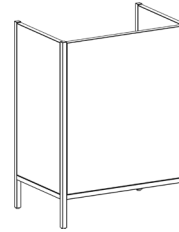

**Podium**  
36"W 24"D 48"H  
42"H Surface

Power Optional

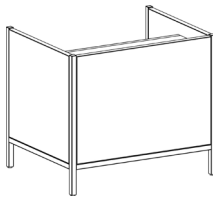

**Witness Stand**  
38"W 30"D 33"H  
30"H Worksurface

Power Optional



**Counsel Table**  
60-84"W 36-42"D 30"H  
36"H Worksurface

Power Optional





Roland Study Tables

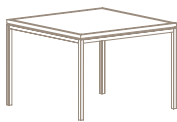

StudyTable

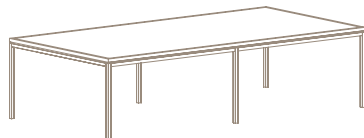

Conference Table



Round Occasional Table



End Panel

AGATI is defined by versatility. Designs combine a unique blend of aesthetics and engineering, distinguished by their eclectic styles. Inspired by the need for furniture that is both timeless and universal, AGATI is committed to the design and engineering of each and every piece.

Furniture built to last a lifetime means investing in the future. AGATI is dedicated to implementing sound environmental practices such as utilizing domestic reforested lumber, as well as reusable packaging materials. AGATI believes in helping preserve resources at no expense to the integrity of the product or the satisfaction of the customer.

Celebrated for its design. Chosen for its quality.



**AGATI**

1219 W Lake Street Chicago, Illinois 60607 T 312.829.1977 F 312.829.8249 [www.agati.com](http://www.agati.com)

©2013 AGATI, Chicago, Illinois Printed in USA 3/13\_2M

BROWN



**AGATI**  
FURNITURE



Brown Panel Carrel with metal reveals.

Brown Panel Tables with reveal options, below and right, shown with Ella Arm Chair.







Brown Leg Base Study Table with data port option.

## BROWN Collection

The Brown Collection makes a bold statement with a design motif achieved through the use of reveals. Horizontal and vertical reveal details accent table base ends, showcasing a strong, clean line design. Originally designed for the U.S. Courthouse Libraries, the Brown Collection featured contemporary solid wood, panel tables. Inset wood veneer tops and solid wood square edges grace each table giving the collection its handsome yet simple style.

Melding metal and wood, the Brown Collection bridges the gap between traditional and contemporary. Optional metal reveals serve to highlight the Brown Collection's flawless lines and solid construction. Striking and enduring, the Brown Collection includes study tables, book tables, carrels, atlas and dictionary stands, end panels, shelving and reference desks. Visit [www.agati.com](http://www.agati.com) to see more.





Brown Study Tables with Curtis Chairs. Augustana College, Souix Falls, SD.

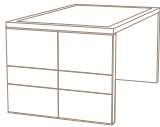

Panel Study Table

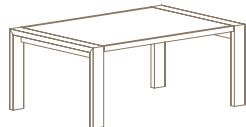

Leg Base Study Table

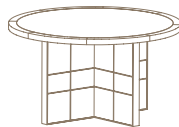

Round X-Base Table

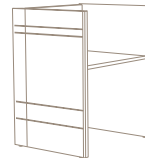

Panel Carrel



End Panel

AGATI is defined by versatility. Designs combine a unique blend of aesthetics and engineering, distinguished by their eclectic styles. Inspired by the need for furniture that is both timeless and universal, AGATI is committed to the design and engineering of each and every piece.

Furniture built to last a lifetime means investing in the future. AGATI is dedicated to implementing sound environmental practices such as utilizing domestic reforested lumber, as well as reusable packaging materials. AGATI believes in helping preserve resources at no expense to the integrity of the product or the satisfaction of the customer.

Celebrated for its design. Chosen for its quality.



**AGATI**

1219 W Lake Street Chicago, Illinois 60607 T 312.829.1977 F 312.829.8249 [www.agati.com](http://www.agati.com)

©2010 Agati, Chicago, Illinois Printed in USA 12/10\_2M



**BROWN  
COURTROOM**



Judges Table



Courtroom Podium



Witness Stand



Counsel Table

# The Brown Courtroom Collection

The Brown Collection Courtroom Suite includes Judge's Bench, Lectern, two Witness Stands, and two Attorney Tables. AGATI's Brown Collection makes a bold statement with a design motif achieved through the use of reveals.

---

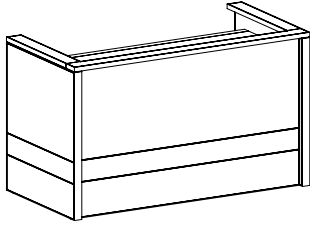

**Judges Bench**  
60-84"W 36"D 42"H  
36"H Worksurface

Power Optional

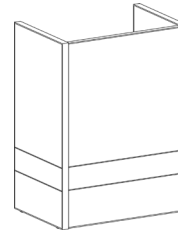

**Podium**  
36"W 24"D 48"H  
42"H Surface

Power Optional

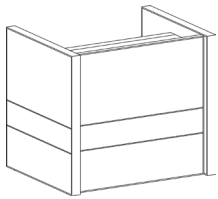

**Witness Stand**  
38"W 30"D 33"H  
30"H Worksurface

Power Optional

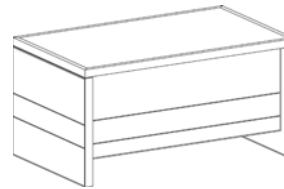

**Counsel Table**  
60-84"W 36-42"D 30"H  
36"H Worksurface

Power Optional





CERINO





Cerino Round Study Table in maple with square edge, shown with Baja chair, top.



Square Study Table in maple with inset Marmoleum top and data port option, center.



Cerino Study Carrel with lighting option, left.

Modified upholstered bench, below right.





Cerino Rectangular Study Table in cherry.

## CERINO Collection

The Cerino Collection is universal in both appeal and design. Streamlined and stylish, Cerino complements its setting. The collection is functional and durable, without overpowering its surroundings or accompanying furniture.

Cerino tables and carrels feature heavy, solid wood, tapered legs with a routed foot detail on the bottom of the legs. Tops are available with either wood veneer or Marmoleum insets with a solid wood, chamfered edge or a square edge. All Cerino tables and carrels support data and power needs, as well.

The Cerino Collection includes study tables, occasional tables, benches and carrels. It also adapts well to children's areas. Visit [www.agati.com](http://www.agati.com) for more options.







Cerino Carrels, Tables and Self-check station. Jet side chairs.



Square Study Table



Round Table

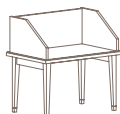

Study Carrel

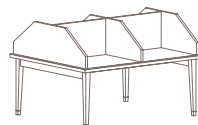

Dual Face Table Carrel



Children's Table

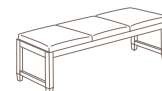

3-Seat Bench

AGATI is defined by versatility. Designs combine a unique blend of aesthetics and engineering, distinguished by their eclectic styles. Inspired by the need for furniture that is both timeless and universal, AGATI is committed to the design and engineering of each and every piece.

Furniture built to last a lifetime means investing in the future. AGATI is dedicated to implementing sound environmental practices such as utilizing domestic reforested lumber, as well as reusable packaging materials. AGATI believes in helping preserve resources at no expense to the integrity of the product or the satisfaction of the customer.

Celebrated for its design. Chosen for its quality.



**AGATI**

1219 W Lake Street Chicago, Illinois 60607 T 312.829.1977 F 312.829.8249 [www.agati.com](http://www.agati.com)

©2013 Agati, Chicago, Illinois Printed in USA 3/13\_2M



WILLIAMS





Williams Study Table  
in maple, left.



Williams Study Carrel  
in maple.



Williams Table Carrel in maple  
with inset Marmoleum top,  
shown with Ella Chair, center.



Williams Display Tables.



Williams Bench





Canton Public Library, Canton, MI

## WILLIAMS Collection

Parallel lines and crisp angles give the AGATI Williams Collection its contemporary flair. Constructed from solid wood, the Williams Collection adds modern appeal while retaining the warmth of wood furniture.

Streamlined and functional, the collection complements, rather than dominates, its environment. Williams tables feature flush end apron rails, end and center stretchers and are supported by solid wood bases and straight legs.

The Williams Collection includes study tables, occasional tables, carrels, table carrels with divider options and benches. Visit [agati.com](http://agati.com) to see more.







University of North Florida

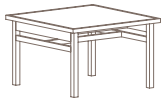

Square Study Table



Rectangular Study Table

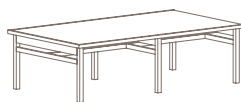

Conference Table



Round X-base Table

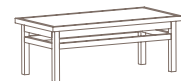

Occasional Table

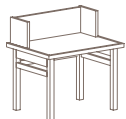

Study Carrel

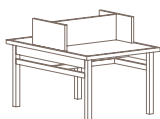
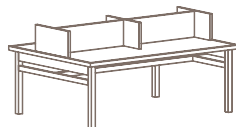
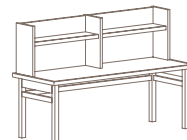

Table Carrel



4-Person Double Face  
Table Carrel



Index Table



Bench

AGATI is defined by versatility. Designs combine a unique blend of aesthetics and engineering, distinguished by their eclectic styles. Inspired by the need for furniture that is both timeless and universal, AGATI is committed to the design and engineering of each and every piece.

Furniture built to last a lifetime means investing in the future. AGATI is dedicated to implementing sound environmental practices such as utilizing domestic reforested lumber, as well as reusable packaging materials. AGATI believes in helping preserve resources at no expense to the integrity of the product or the satisfaction of the customer.

Celebrated for its design. Chosen for its quality.



**AGATI**

1219 W Lake Street Chicago, Illinois 60607 T 312.829.1977 F 312.829.8249 www.agati.com

©2013 AGATI, Chicago, Illinois Printed in USA 3/13\_2M



CHARLES





Left: Charles Lounge Chairs with square splat detail, left, and with dentil detail, right.



Bottom: Charles Triple Seat Bench with upholstered seat, and Occasional Table.





Charles Study Table shown with Charles Side Chair.

## CHARLES Collection

The Charles Collection finds its inspiration in the crisp, design details of 20th century architect, designer and artist, Rennie Mackintosh. Featuring a “three square” motif integral to Mackintosh’s design vocabulary, the Charles Collection is quickly identified by its pierced cutouts or applied squares.

Evocative of Mission style’s dignified integrity and fluid lines, the Charles Collection showcases a decorative, solid wood frame. Completing the Charles Collection are chairs, benches, lounge chairs, tables, occasional tables, carrels, dictionary and atlas stands, and end panels. Visit [www.agati.com](http://www.agati.com) to see more options.

Charles Collection also includes children’s table and chairs.







Coralville Public Library, Coralville, IA.

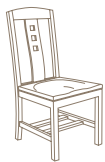

Side Chair



Arm Chair

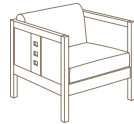

Lounge Chair

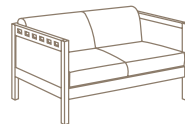

Two Seat Sofa

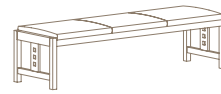

Bench

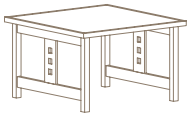

Study Table

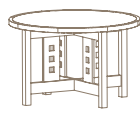

X-Base Table



Occasional Table

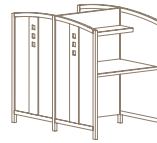

Double Faced Carrel



Atlas Stand



End Panel

AGATI is defined by versatility. Designs combine a unique blend of aesthetics and engineering, distinguished by their eclectic styles. Inspired by the need for furniture that is both timeless and universal, AGATI is committed to the design and engineering of each and every piece.

Furniture built to last a lifetime means investing in the future. AGATI is dedicated to implementing sound environmental practices such as utilizing domestic reforested lumber, as well as reusable packaging materials. AGATI believes in helping preserve resources at no expense to the integrity of the product or the satisfaction of the customer.

Celebrated for its design. Chosen for its quality.



**AGATI**

1219 W Lake Street Chicago, Illinois 60607 T 312.829.1977 F 312.829.8249 [www.agati.com](http://www.agati.com)

© 2010 AGATI, Chicago, Illinois Printed in USA 12/10\_2M



CHARLES-DEPAUL  
COURTROOM



Judges Table



Courtroom Podium



Witness Stand



Counsel Table

# The Charles-DePaul Courtroom Collection

We merged the best elements from our two most popular transitional styles in the Charles-DePaul Courtroom Suite. Pulling from the popularity of the center-splat style found in the Charles Collection, we maintained the elegance of simplicity, as epitomized in the DePaul Collection to design the Charles-DePaul Courtroom Suite.

---

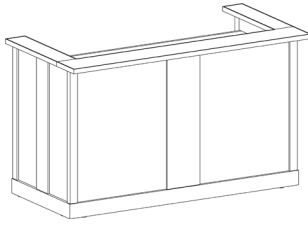

**Judges Bench**  
60-84"W 36"D 42"H  
36"H Worksurface

Power Optional

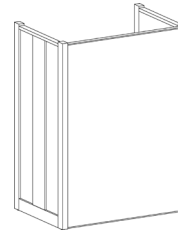

**Podium**  
36"W 24"D 48"H  
42"H Surface

Power Optional

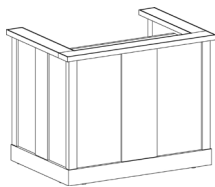

**Witness Stand**  
38"W 30"D 33"H  
30"H Worksurface

Power Optional

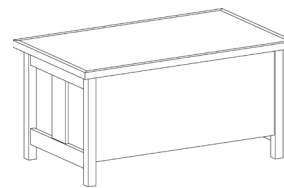

**Counsel Table**  
60-84"W 36-42"D 30"H  
36"H Worksurface

Power Optional



DEPAUL





DePaul Armchair  
with upholstered seat and  
Side Chair.



DePaul Round  
X-Base Table.



DePaul Armless  
Back Bench in cherry.



DePaul Back Bench  
with arms in maple.





DePaul Study Table and Side Chair.

## DE PAUL Collection

The DePaul Collection exemplifies transitional design. Starting with classic, traditional design and adding a twist of contemporary, the DePaul Collection is one of Agati's most popular collections. Originally designed for the DePaul University Law Library Project, the collection emphasizes the inherent qualities of the wood grain, the elegance of the design's simplicity and the importance of craftsmanship.

Generous, vertical lines adorn a trestle base construction. DePaul tables emphasize their stepped, vertical detail showcasing classic design with a modern flair. Solid wood chair and bench frames feature vertical back slats, side leg and double center stretchers. Chairs come in either carved wood saddle seats or upholstered slip seats.

The DePaul Collection includes chairs, study tables, carrels, a variety of benches, dictionary and atlas stands, plus end panels. Visit [www.agati.com](http://www.agati.com) to see more.





DePaul University Law Library, Chicago, IL



Side Chair



Arm Chair

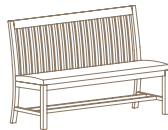

Back Bench

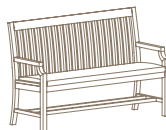

Back Bench with Arms



Upholstered Bench

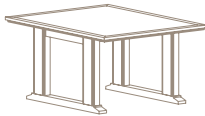

Study TableR



ound Table

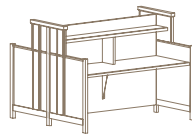

Double Face Carrel



Dictionary & Atlas Stand

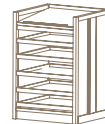

End Panel

AGATI is defined by versatility. Designs combine a unique blend of aesthetics and engineering, distinguished by their eclectic styles. Inspired by the need for furniture that is both timeless and universal, AGATI is committed to the design and engineering of each and every piece.

Furniture built to last a lifetime means investing in the future. AGATI is dedicated to implementing sound environmental practices such as utilizing domestic reforested lumber, as well as reusable packaging materials. AGATI believes in helping preserve resources at no expense to the integrity of the product or the satisfaction of the customer.

Celebrated for its design. Chosen for its quality.



**AGATI**

1219 W Lake Street Chicago, Illinois 60607 T 312.829.1977 F 312.829.8249 www.agati.com

©2014 AGATI, Chicago, Illinois Printed in USA



FRYE





Frye Round Study Table,  
and Occasional Table with  
foot blocks, above.

Frye Double Seat Bench with  
upholstered seat, left.



Frye Low Back Lounge Chairs,  
and Occasional Table, below.





Abraham Lincoln Presidential Library, Springfield, IL

## FRYE collection

The Frye Collection typifies the Arts and Crafts movement. Reflective of its 19th century elegance, the Frye Collection is simple in design and reliable in construction. Tables are made out of solid wood frames with end slats. Lounge chairs provide upholstered seats and backs and come in both high or low back versions. Two and three seat sofas are also available.

A modest, welcoming collection that doesn't overpower its setting, the Frye Collection includes study tables, carrels, benches, lounge chairs, occasional tables and display items. Visit [www.agati.com](http://www.agati.com) to see more.



Frye Pull Up Chair





Fry Two Person Study Carrel with foot block option.



Lounge Chair



Two Seat Sofa

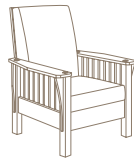

High Back Lounge Chair

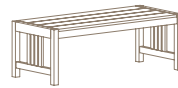

Bench



Occasional Table

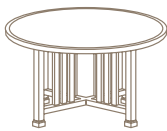

Round Study Table

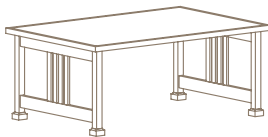

Rectangular Study Table

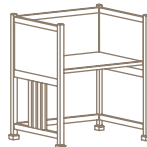

Study Carrel

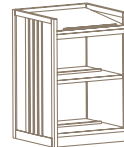

Dictionary and Atlas Stands

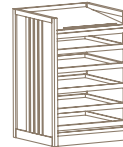

End Panel

AGATI is defined by versatility. Designs combine a unique blend of aesthetics and engineering, distinguished by their eclectic styles. Inspired by the need for furniture that is both timeless and universal, AGATI is committed to the design and engineering of each and every piece.

Furniture built to last a lifetime means investing in the future. AGATI is dedicated to implementing sound environmental practices such as utilizing domestic reforested lumber, as well as reusable packaging materials. AGATI believes in helping preserve resources at no expense to the integrity of the product or the satisfaction of the customer.

Celebrated for its design. Chosen for its quality.



**AGATI**

1219 W Lake Street Chicago, Illinois 60607 T 312.829.1977 F 312.829.8249 www.agati.com

©2010 Agati, Chicago, Illinois Printed in USA 12/10\_2M

MYLES





Myles Double Faced Table  
Carrel, in cherry, with  
inset Marmoleum top, left.



Myles Round X-Base  
Study Table, center.



Myles Study Table shown  
with Prairie chair, below.





Lexington Public Library, Lexington, NE

## MYLES Collection

The AGATI Myles Collection can attribute its beauty to its simple lines and modest design. Influenced by Arts and Crafts styling, the Myles Collection features solid wood, triple slat detail set against a solid wood frame and panel construction.

Carrels feature three-fourths height end panels and overhead storage shelves. The Myles Collection's clean, unobtrusive design allows collection pieces to blend with their environment and coordinate seamlessly with other AGATI Collections.

The Myles Collection includes a large selection of study tables, occasional tables, carrels, atlas and dictionary stands, benches, stools and end panels. Visit [www.agati.com](http://www.agati.com) to view more.



Myles Lounge Chair



Myles 4-person double faced Study Carrel

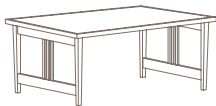

Study Table

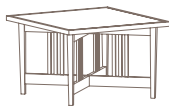

X-Base Study Table

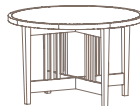

Round Study Table



Square Occasional



Round Occasional



End Panel

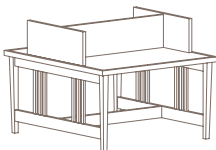
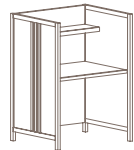
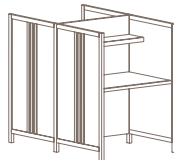

Table Carrel



Carrel



Double Face Carrel

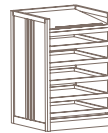

Atlas Stand

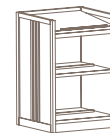

Dictionary Stand

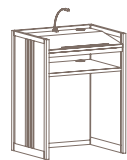

Podium

AGATI is defined by versatility. Designs combine a unique blend of aesthetics and engineering, distinguished by their eclectic styles. Inspired by the need for furniture that is both timeless and universal, AGATI is committed to the design and engineering of each and every piece.

Furniture built to last a lifetime means investing in the future. AGATI is dedicated to implementing sound environmental practices such as utilizing domestic reforested lumber, as well as reusable packaging materials. AGATI believes in helping preserve resources at no expense to the integrity of the product or the satisfaction of the customer.

Celebrated for its design. Chosen for its quality.



**AGATI**

1219 W Lake Street Chicago, Illinois 60607 T 312.829.1977 F 312.829.8249 www.agati.com

©2013 AGATI, Chicago, Illinois Printed in USA 3/13\_2M



GOTHIC





Gothic Study Carrel with  
Gothic Armchair, right.  
Gothic Square Study Table  
with lattice detailing, below.



Gothic Trestle Table  
with Gothic Side Chair







Duke University Chapel, Durham, NC

Bryan Becker Photography

## GOTHIC collection

Designed in response to the University of Chicago's Hutchinson Commons Project, the Gothic Collection is a study in detail. Harkening back to 12th century Cathedral Design, the Gothic is a visually rich collection.

Solid wood frames are embellished by a quatrefoil detail or a beautiful lattice design which adds detail and provides a source of light and openness to the pieces. Skillfully designed, the Collection's elegance belies its structure. Chairs and tables feature solid wood frames and are constructed to endure. The Gothic designs etched into each piece make the collection recognizable for its beauty and character.

The Gothic Collection includes chairs, lounge chairs, study tables, occasional tables, carrels, dictionary and atlas stands and end panels.







Boston College, Stokes Hall, Boston, MA



Side Chair



Arm Chair

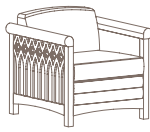

Lounge Chair



Round Study Table



Square Study Table

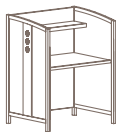

Carrel

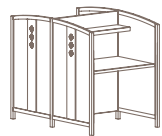

Double Faced Carrel



Atlas Stand



Dictionary Stand



End Panel

AGATI is defined by versatility. Designs combine a unique blend of aesthetics and engineering, distinguished by their eclectic styles. Inspired by the need for furniture that is both timeless and universal, AGATI is committed to the design and engineering of each and every piece.

Furniture built to last a lifetime means investing in the future. AGATI is dedicated to implementing sound environmental practices such as utilizing domestic reforested lumber, as well as reusable packaging materials. AGATI believes in helping preserve resources at no expense to the integrity of the product or the satisfaction of the customer.

Celebrated for its design. Chosen for its quality.



**AGATI**

1219 W Lake Street Chicago, Illinois 60607 T 312.829.1977 F 312.829.8249 [www.agati.com](http://www.agati.com)

© 2013 AGATI, Chicago, Illinois Printed in USA 3/13\_2M



GOTHIC  
COURTROOM



Judges Table



Courtroom Podium



Witness Stand



Counsel Table

# The Gothic Courtroom Collection

The Gothic Collection Courtroom Suite includes Judge's Bench, Lectern, two Witness Stands, and two Attorney Tables. AGATI's Gothic Collection is distinguished by an intricate quatrefoil and lattice designs etched into each piece making it recognizable for its beauty and character.

---

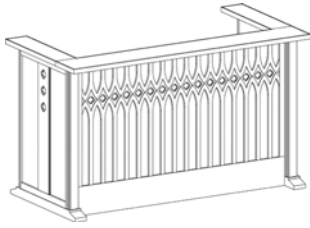

**Judges Bench**  
60-84"W 36"D 42"H  
36"H Worksurface

Power Optional

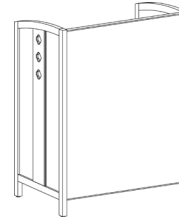

**Podium**  
36"W 24"D 48"H  
42"H Surface

Power Optional

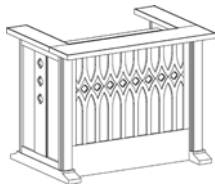

**Witness Stand**  
38"W 30"D 33"H  
30"H Worksurface

Power Optional

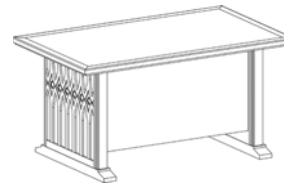

**Counsel Table**  
60-84"W 36-42"D 30"H  
36"H Worksurface

Power Optional



PRIMARY



**AGATI**  
FURNITURE





Primary Study Table in maple, above.  
Primary Study Carrel, right.



Primary Librarian Desk, with Marmoleum top,  
above, shown with Behrmann Chair.  
Primary Pedestal Filing Cabinets.  
Also see our Primary Shelving brochure  
for additional storage options.





Primary Modular Circulation Desk with Corner Units.

## PRIMARY Collection

The AGATI Primary Collection was born out a need for the essentials. A collection of simply designed yet beautifully built furniture, the Primary Collection strives to meet budgets without sacrificing style. Ideal for the primary education sector where superfluous furniture need not apply, the Primary Collection highlights affordability and flexibility. Pair a Primary desk with file cabinet pedestals or configure the modular circulation desk to meet any size space. This collection of furniture proves to be space conscientious and durable enough for the everyday use of educational environments.

Available in standard AGATI finishes, the Primary Collection boasts study tables, carrels, a variety of desks, shelving and storage units. The AGATI Ella, Prairie and Behrmann chairs are often chosen to complement the Primary Collection. Visit [www.agati.com](http://www.agati.com) to see more.

Primary Round Childrens Table with Behrmann Chairs in maple.





Primary Round Study Table in Cherry with Ella Slat Back Side Chairs.

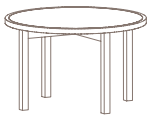

Round Study Table

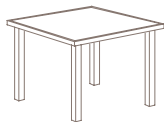

Square Study Table



Librarian Desk

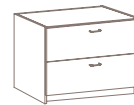

Lateral File Cabinet



Pedestal File Cabinet

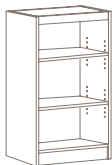

Single Face  
Shelving Unit



Double Face  
Shelving Unit

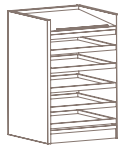

Atlas & Dictionary  
Stands



Periodical Shelving



Wardrobe

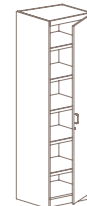

Storage Closet

AGATI is defined by versatility. Designs combine a unique blend of aesthetics and engineering, distinguished by their eclectic styles. Inspired by the need for furniture that is both timeless and universal, AGATI is committed to the design and engineering of each and every piece.

Furniture built to last a lifetime means investing in the future. AGATI is dedicated to implementing sound environmental practices such as utilizing domestic reforested lumber, as well as reusable packaging materials. AGATI believes in helping preserve resources at no expense to the integrity of the product or the satisfaction of the customer.

Celebrated for its design. Chosen for its quality.



**AGATI**

1219 W Lake Street Chicago, Illinois 60607 T 312.829.1977 F 312.829.8249 www.agati.com

©2010 Agati, Chicago, Illinois Printed in USA 12/10\_2M



# PRIMARY SHELVING & STORAGE



## TOPCAP EDGE PROFILES



The AGATI Primary Collection was born out a need for the essentials. A collection of simply designed yet beautifully built furniture, the Primary Collection strives to meet budgets without sacrificing style.

Primary shelving and storage units are available in standard AGATI finishes. Shelving units are designed to withstand years of use and maintain a timeless aesthetic. Single units feature front facing shelves and a finished back while double face units provide more shelving and a finished center panel.

The Primary collection also includes study tables, carrels, desks, storage and display items.

**AGATI**  
FURNITURE

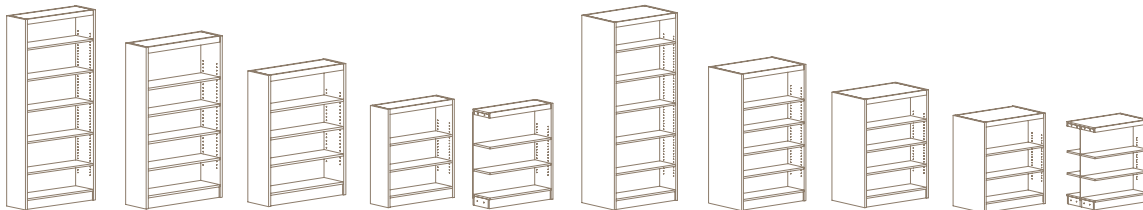

Single Face Units  
36w x 12d Starter and Adder Units

Double Face Units  
36w x 22d Starter and Adder Units

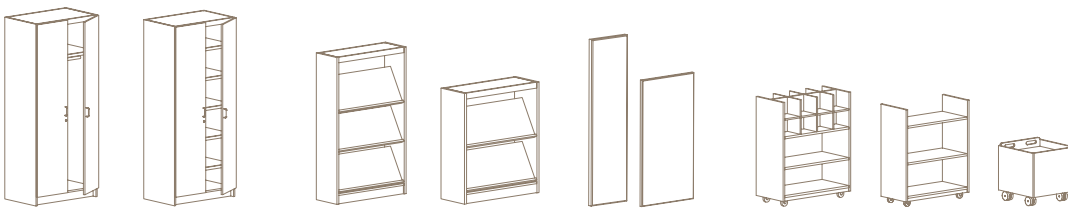

Wardrobe

Storage Cabinet

Periodical Display

End Panels

Bookcarts and Booktrucks

AGATI is defined by versatility. Designs combine a unique blend of aesthetics and engineering, distinguished by their eclectic styles. Inspired by the need for furniture that is both timeless and universal, AGATI is committed to the design and engineering of each and every piece.

Furniture built to last a lifetime means investing in the future. AGATI is dedicated to implementing sound environmental practices such as utilizing domestic reforested lumber, as well as reusable packaging materials. AGATI believes in helping preserve resources at no expense to the integrity of the product or the satisfaction of the customer.

Celebrated for its design. Chosen for its quality.

**AGATI**



## BAJA



The Baja Chair is a versatile, modern chair that offers a sloping, generous seat pan and a comfortable sit. A stylish back panel provides an abundant amount of back support. Its solid wood frame is complemented by formed wood veneer seat and back panels.

The Baja Chair is also available as an armchair and a stool. It is available in three finishes: maple, cherry or espresso. It can also feature an upholstered seat. An optional book rack beneath the seat makes the Baja Chair ideal for individual seating in places of gathering. Visit [www.agati.com](http://www.agati.com) to see more.





Baja Chair



Baja Chair,  
upholstered seat



Baja Arm Chair



Baja Counter Stool



Baja High Stool

AGATI is defined by versatility. Designs combine a unique blend of aesthetics and engineering, distinguished by their eclectic styles. Inspired by the need for furniture that is both timeless and universal, AGATI is committed to the design and engineering of each and every piece.

Furniture built to last a lifetime means investing in the future. AGATI is dedicated to implementing sound environmental practices such as utilizing domestic reforested lumber, as well as reusable packaging materials. AGATI believes in helping preserve resources at no expense to the integrity of the product or the satisfaction of the customer.

Celebrated for its design. Chosen for its quality.



# AGATI

1219 W Lake Street Chicago, Illinois 60607 T 312.829.1977 F 312.829.8249 [www.agati.com](http://www.agati.com)

©2016 AGATI, Chicago, Illinois Printed in USA 3/13\_2M

# SENSI



The Sensi chair embodies modern chic in a colorful, durable, functional chair that also stacks! A unique built-in ganging mechanism slides out from under the seat to allow Sensi chairs to be easily joined into straight, even rows.



**AGATI**  
FURNITURE



Sensi Chairs with Roland Table

## SENSI

Featuring a refined original design, Sensi's frame structure is made of high quality materials. Frames are available in chrome or satin, while the seat and backrest are formed from bent plywood. Chairs are easy to stack (up to 5 chairs), providing additional storage possibilities. A built in ganging mechanism also allowed chairs to be joined into rows using metal connecting elements that slide from under the seat. Thanks to their versatility, Sensi chairs can be arranged into multiple combinations, while a modern color range of Formica laminates offer a stylish appearance. Sensi is also available in Beech veneer, stain to match or standard AGATI finishes.



Sensi High Stool



**AGATI**



## FAN



AGATI's Fan is a unique armchair noticed immediately for its distinctive character. An elegant shell shape seat featuring precise stitching is its most striking feature. The Fan Chair epitomizes the modern arm chair, best used in open spaces, conference rooms, receptions and home offices. The shell is made of a high quality cold melded foam technology supported by a sleek, chrome disc base with a self-centering cylinder. Fan is available in a variety of colors and fabrics, with contrasting stitching.

**AGATI**

CLASSIC  
CHAIRS





## CLASSIC CHAIRS

### CHARLES

Inspired by the crisp design details of Charles Rennie Mackintosh. Solid wood frame, three square motif on back splat. Arm or armless with carved wood or upholstered seat. Also available as a bench.



### DEPAUL

The DePaul collection emphasizes the inherent qualities of the wood grain, the elegance of the design's simplicity, and the importance of craftsmanship.

Solid wood frame with vertical back slats. Arm or armless with carved wood or upholstered seat. Also available in a variety of bench options.



### GOTHIC

The Gothic is a study in detail, but it's elegance belies its structure. Gothic chairs are solidly constructed, yet maintain a sense of airiness with its lattice design.

Solid wood frame with a quatrefoil detail on back splat. Arm or armless with carved wood or upholstered seat. Also available as a bench.





## BEHRMANN

The Behrmann provides a solidly constructed chair – straightforward and simply designed. Use as a side wood chair or upholster for style and comfort. The modest design of the Behrmann chair makes it very adaptable.

Solid wood frame with vertical back slats, leg stretchers with bookrack, and modified arched top back rail. Carved wood saddle seat or upholstered slip seat.



## PRAIRIE

Drawing on the Midwest's Prairie School of Architecture, these simple and well-designed chairs are a popular favorite.

Solid wood frame with horizontal, vertical or wavy back slats. Carved wood saddle seat. Also available as a high stool.

AGATI chairs are characterized by a blend of aesthetics and engineering to create exceptional and enduring furniture. Chairs are constructed using Agati's signature mortise and tenon joinery. Each right angled joint is secured with a pin, making the strongest possible joint. To ensure superior stability, many chairs feature a one piece, solid wood back post from floor to top rail. AGATI chairs are timeless in beauty and will enhance their environments for many years to come.

AGATI's custom capabilities provide the flexibility to accommodate various projects and budgets. See our Custom Options information sheet to view some of the many options available. Many of these chairs are also available in child or youth sizes. Go to [www.agati.com](http://www.agati.com) to view more options.

Prairie High Stool





## WHITE

The White chair is designed and engineered for optimal comfort and durability. These classic chair and stool designs look great in contemporary or traditional settings year after year.

Solid wood frame with vertical back slats or single back splat with three square motif. Carved wood saddle or upholstered seat. Also available as a high stool.

## Custom Chair Options

AGATI simplifies the process of working with custom modifications. Whether it is a modification to an existing collection or a new design idea; our in-house design and engineering team assists from concept to completion. Here are just a few of the custom options available. See our Custom Options sheet for more details.



### BACK

Carved details  
Wood inlays  
Custom splats or slats  
Fold down kneeler

### TOP RAIL

Cutout details  
Custom rails  
Laser inscription

### SEAT

Carved wood seat  
Cloth upholstery  
Leather upholstery

### STRETCHERS

Custom stretchers  
Book Rack  
Hymnal Box

AGATI is defined by versatility. Designs combine a unique blend of aesthetics and engineering, distinguished by their eclectic styles. Inspired by the need for furniture that is both timeless and universal, AGATI is committed to the design and engineering of each and every piece.

Furniture built to last a lifetime means investing in the future. AGATI is dedicated to implementing sound environmental practices such as utilizing domestic reforested lumber, as well as reusable packaging materials. AGATI believes in helping preserve resources at no expense to the integrity of the product or the satisfaction of the customer.

Celebrated for its design. Chosen for its quality.



# AGATI

1219 W Lake Street Chicago, Illinois 60607 T 312.829.1977 F 312.829.8249 [www.agati.com](http://www.agati.com)

© 2010 AGATI, Chicago, Illinois Printed in USA 12/10\_2M



## Custom Chairs

AGATI chairs are characterized by a blend of aesthetics and engineering to create exceptional and enduring furniture. Standard collections vary in design from traditional to contemporary, complimenting a wide range of interiors. AGATI's custom capabilities provide the flexibility to accommodate various projects and budgets.

Chairs are constructed using AGATI's signature mortise and tenon joinery. Each right angled joint is secured with a pin, making the strongest possible joint. To ensure superior stability, many chairs feature a one piece, solid wood back post from floor to top rail.

AGATI is a nationally recognized leader in furniture design, quality and performance. AGATI chairs are timeless in beauty and will enhance their environments for many years to come.

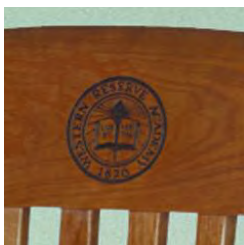

Laser Inscription



Cutout Detail

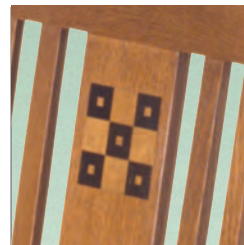

Wood Inlay



Custom Back Splats



## Custom Chair Options

AGATI simplifies the process of working with custom modifications. Whether it is a modification to an existing collection or a new design idea; our in-house design and engineering team assists from concept to completion. Here are just a few of the custom options available.

### Top Rail

Cutout Detail

Custom Rails

Laser Inscription



### Back

Carved Details

Wood Inlays

Custom Splats or Slats



### Seat

Carved Wood Seat

Cloth Upholstery

Leather Upholstery



### Stretchers

Custom Stretchers

Book Rack

Hymnal Box



### Wood Species and Finishes

Standard wood species include plain sliced Cherry, Maple and Red Oak. Others available upon request. Custom finishes and stain matching are also available.

**AGATI**

GEE  
MODULAR



The basic Gee starts as a lounge chair on steel, metal legs. Use as an armless or arm chair, add privacy side panels, back panels or pair with occasional tables.



Configure as a pinwheel, add a tablet arm option and maximize space while affording each user individual privacy.

Multiply the Gee Lounge chair to create functional, sleek seating where space is a premium. Gang individual Gee chairs together, add occasional tables, and the basic Gee is transformed. Ideal for open or common areas, the Gee accommodates multiple users in ultimate style and comfort.







## GEE MODULAR

The Gee Lounge chair is more than just a single chair. Expand the basic Gee Lounge to accommodate small groups while maintaining privacy. Connect two Gee Lounge chairs with a joining occasional table. Add back panels to allow for additional privacy while decreasing sound overflow. Create a small public space, add casters for mobility. No matter what the size or the need, Gee Modular is designed to suit your space. Comfort is a necessity. Configurations are endless. Let your imagination flow.

Visit [www.agati.com](http://www.agati.com) to see more options.





Add privacy side panels, back panels or pair with occasional tables. T1Visions Touchscreen option shown on cover.

AGATI is defined by versatility. Designs combine a unique blend of aesthetics and engineering, distinguished by their eclectic styles. Inspired by the need for furniture that is both timeless and universal, AGATI is committed to the design and engineering of each and every piece.

Furniture built to last a lifetime means investing in the future. AGATI is dedicated to implementing sound environmental practices such as utilizing domestic reforested lumber, as well as reusable packaging materials. AGATI believes in helping preserve resources at no expense to the integrity of the product or the satisfaction of the customer.

Celebrated for its design. Chosen for its quality.



# AGATI

1219 W Lake Street Chicago, Illinois 60607 T 312.829.1977 F 312.829.8249 [www.agati.com](http://www.agati.com)

© 2013 AGATI, Chicago, Illinois Printed in USA 3/13\_2M



GEE  
MODULAR  
*Curvy*



The Gee Lounge is more than just a single chair. Expand the basic Gee to accommodate small groups while maintaining privacy. Connect two Gee lounge chairs with a joining occasional table. Add back panels to allow for additional privacy while decreasing sound overflow or create a small public space.

No matter what the size or the need, the Gee Lounge Chair is designed to fit your space. Comfort is a necessity while configurations are endless. Let your imagination flow.



**AGATI**



GEE  
MODULAR  
*Curvy*

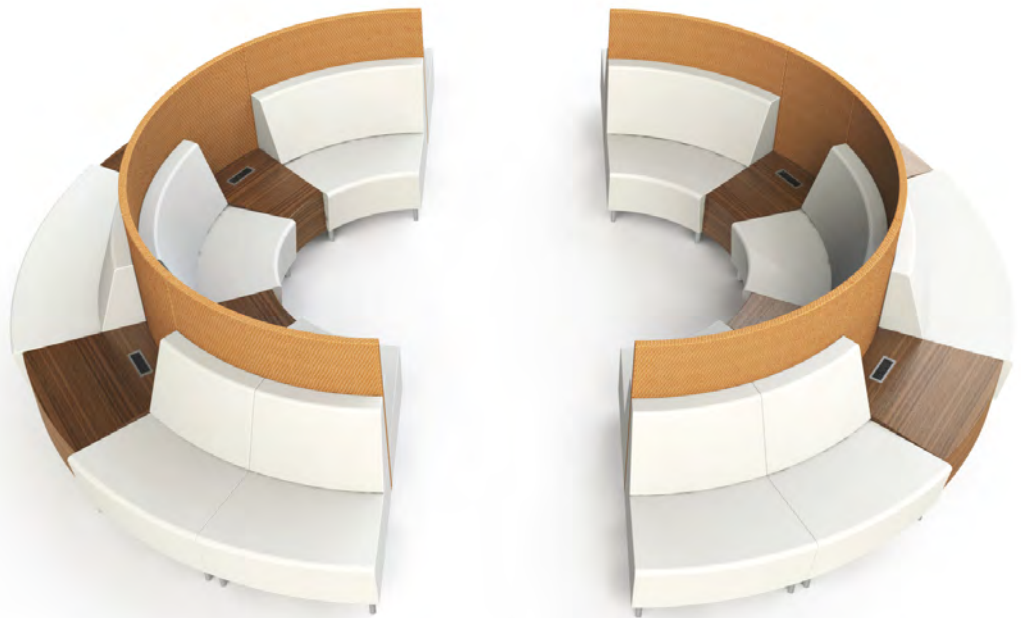

**AGATI**

[www.agati.com](http://www.agati.com)

HAMPTON



**AGATI**  
FURNITURE



Hampton Straight with wood veneer screen



Two basic Curves



Hampton Curve with fabric screens and casters



Metal Leg Base



Plinth Base





Hampton Curve shown in "S" configuration with wood veneer surrounds.

## HAMPTON Seating Collection

Today's environments call for not only effective but creative use of space. The need for collaboration and innovation prevails, without sacrificing design and style. AGATI answers that call with its sophisticated Hampton Seating. Available in a variety of configurations, the Hampton offers adaptable form and function allowing users to sit in comfort, while meeting in style.

The basic Hampton is perfect for a casual and open space, while optional surrounds can be added to envelop users for more seclusion. Both the curved and straight Hampton can be covered in chic fabrics, backed in sleek veneers or high pressure laminate. The Hampton can rest on metal or caster legs, or a plinth base. For additional separation, custom privacy screens may be added. An ability to stand alone or build-in allows the Hampton to provide ultimate flexibility in space configuration. No matter how big or small the space, AGATI's Hampton adds abundant seating and flair to spaces everywhere.







Hampton Curves shown with wood veneer screens

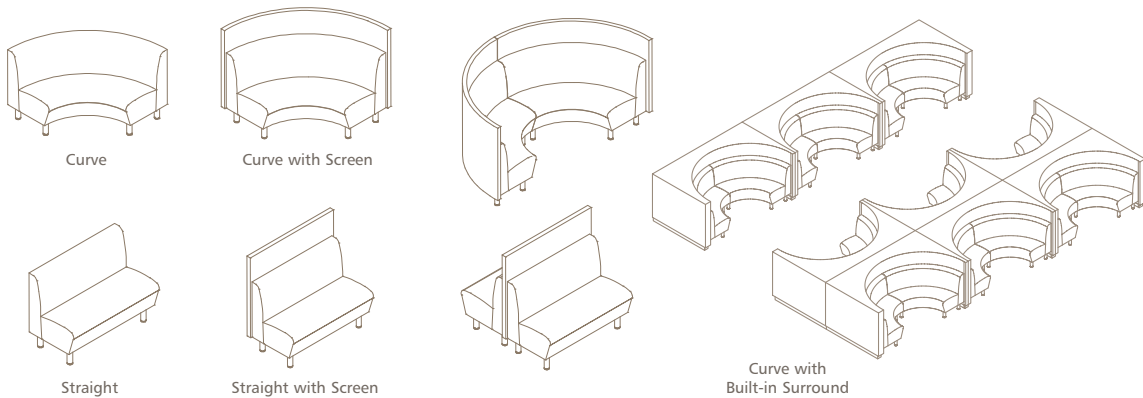

AGATI is defined by versatility. Designs combine a unique blend of aesthetics and engineering, distinguished by their eclectic styles. Inspired by the need for furniture that is both timeless and universal, AGATI is committed to the design and engineering of each and every piece.

Furniture built to last a lifetime means investing in the future. AGATI is dedicated to implementing sound environmental practices such as utilizing domestic reforested lumber, as well as reusable packaging materials. AGATI believes in helping preserve resources at no expense to the integrity of the product or the satisfaction of the customer.

Celebrated for its design. Chosen for its quality.



**AGATI**

1219 W Lake Street Chicago, Illinois 60607 T 312.829.1977 F 312.829.8249 [www.agati.com](http://www.agati.com)

© 2013 AGATI, Chicago, Illinois Printed in USA 3/13\_2M

# HAMPTON



AGATI's popular, versatile Hampton Seating is expanding its horizons with outer curves! While the basic Hampton is perfect for casual and open spaces, the curved Hampton effectively uses space through a sophisticated and versatile design. The curved Hampton comes in 90 degree segments that can expand to a 180 degree curve to accommodate larger groups. The Hampton features a shorter seat, taller back and a pitch 10 degrees more upright than other AGATI lounge chairs, making it ideal for wherever a work sit is preferable. Both the curve and the straight Hampton can utilize additional surrounds for extra privacy wherever free standing meeting places are needed.



**AGATI**



HAMPTON



**AGATI**

## HAVANA



A stylish, modern alternative to the traditional lounge chair, the Havana's comfort and adaptability make it an essential. Its smaller footprint allows for comfortable lounge seating even when space is at a premium.

Havana is available in a variety of styles from a sumptuous lounge chair with wood or metal legs, to a stylish pull up, with or without upholstered arms. The Havana Pull Up is also available with a retro wood arm, or armcaps, for more institutional settings.

Visit [www.agati.com](http://www.agati.com) to see more.

**AGATI**  
FURNITURE

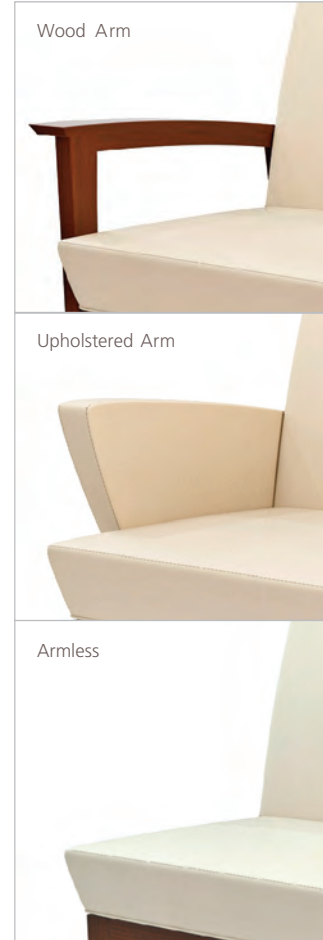

AGATI is defined by versatility. Designs combine a unique blend of aesthetics and engineering, distinguished by their eclectic styles. Inspired by the need for furniture that is both timeless and universal, AGATI is committed to the design and engineering of each and every piece.

Furniture built to last a lifetime means investing in the future. AGATI is dedicated to implementing sound environmental practices such as utilizing domestic reforested lumber, as well as reusable packaging materials. AGATI believes in helping preserve resources at no expense to the integrity of the product or the satisfaction of the customer.

**Celebrated for its design. Chosen for its quality.**



**AGATI**



# RIO



Turn ordinary rooms into dynamic spaces. AGATI's Rio Collection boasts smooth curves and a contemporary yet warm style. Pick a configuration; choose your setting; the Rio Collection morphs to serve the function you need.

Seamless arches, boomerang arms, and solid wood armcaps add to the multitude of options available. With a slight upward tilt to its seat and plenty of room beneath for your feet, the Rio boosts you up after a comfortable sit. Its high back provides support keeping attention crisp. Take advantage of its versatility; take notice of its style. The Rio Collection defines today's movement.



Rio Armless



Rio Boomerang



Rio Tablet with Casters



Rio with Arm caps



Armless Lounge  
Chair



Rio Boomerang  
Arm Chair



Lounge Chair

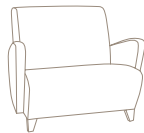

Bariatric  
Lounge Chair

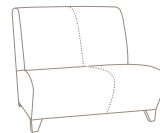

Armless Two Seat  
Settee

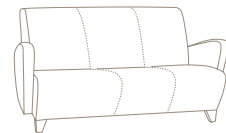

Three Seat Sofa

AGATI is defined by versatility. Designs combine a unique blend of aesthetics and engineering, distinguished by their eclectic styles. Inspired by the need for furniture that is both timeless and universal, AGATI is committed to the design and engineering of each and every piece.

Furniture built to last a lifetime means investing in the future. AGATI is dedicated to implementing sound environmental practices such as utilizing domestic reforested lumber, as well as reusable packaging materials. AGATI believes in helping preserve resources at no expense to the integrity of the product or the satisfaction of the customer.

Celebrated for its design. Chosen for its quality.

# AGATI

1219 W Lake Street Chicago, Illinois 60607 T 312.829.1977 F 312.829.8249 [www.agati.com](http://www.agati.com)

©2016 Agati, Chicago, Illinois Printed in USA 9/10\_2M

## RIO PULL UP



The Rio Pull Up is the perfect complement to its companion chair, the Rio Lounge. A slimmer, more agile version of the Lounge, the Rio Pull Up still features the Rio's signature curves, supported by tapered legs and a solid wood base or a new caster base option.

A stylish, casual alternative to the lounge chair, the Rio Pull Up's adaptability makes it an essential: comfortable lounge seating, contemporary guest seating, or supportive in institutional settings.

The Rio Pull Up is available as a bar or counter height stool, a children's chair and also with high back options. The Rio Pull Up is a part of the AGATI Rio Collection, which includes lounge chairs, settees, sofas and a matching ottoman. Visit [www.agati.com](http://www.agati.com) to see more.





High Back  
Boomerang



Boomerang  
Arm



Rio Caster



High Back  
Upholstered



Children's



Pull Up Chair



Pull Up Chair,  
Armless



Pull Up Chair,  
Boomerang Arm



Pull Up Chair,  
High Back -  
Upholstered Arm



Pull Up Chair,  
High Back -  
Boomerang Arm



High Stool



Childrens  
Pull Up Chair



Childrens Armless  
Pull Up Chair

AGATI is defined by versatility. Designs combine a unique blend of aesthetics and engineering, distinguished by their eclectic styles. Inspired by the need for furniture that is both timeless and universal, AGATI is committed to the design and engineering of each and every piece.

Furniture built to last a lifetime means investing in the future. AGATI is dedicated to implementing sound environmental practices such as utilizing domestic reforested lumber, as well as reusable packaging materials. AGATI believes in helping preserve resources at no expense to the integrity of the product or the satisfaction of the customer.

Celebrated for its design. Chosen for its quality.



# AGATI

# ROMA



It's a rare occasion you see a Roma chair empty. The first chair in a room to be taken, the Roma Lounge Collection offers a warm, inviting sit. Exaggerated and rotund, the Roma's curved linear arms taper to offer a comfortable embrace and ample seat room. AGATI's signature back support provides hours of comfort whether lounging or studying.

Built for institutional use, the Roma Collection's strength is a perfect foil to its pleasing and abundant appeal. Satin nickel or chrome finish cast metal feet cap off each piece. The Roma Collection also includes a settee, sofa and matching ottoman. Visit [www.agati.com](http://www.agati.com) to view more.

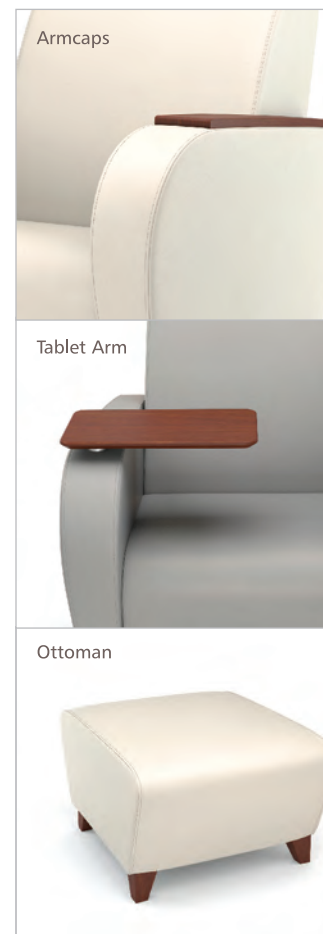

Roma Settee



Lounge  
with Armcaps



Lounge Chair

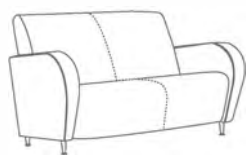

Two Seat Settee

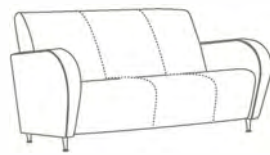

Three Seat Sofa



Ottoman

AGATI is defined by versatility. Designs combine a unique blend of aesthetics and engineering, distinguished by their eclectic styles. Inspired by the need for furniture that is both timeless and universal, AGATI is committed to the design and engineering of each and every piece.

Furniture built to last a lifetime means investing in the future. AGATI is dedicated to implementing sound environmental practices such as utilizing domestic reforested lumber, as well as reusable packaging materials. AGATI believes in helping preserve resources at no expense to the integrity of the product or the satisfaction of the customer.

Celebrated for its design. Chosen for its quality.



# AGATI

1219 W Lake Street Chicago, Illinois 60607 T 312.829.1977 F 312.829.8249 [www.agati.com](http://www.agati.com)

©2016 AGATI, Chicago, Illinois Printed in USA 8/12\_1M



# KEYSTONE



A keystone is defined as the central supporting element of a whole. And like its name, the AGATI Keystone Collection serves as a building block. Start with a simple lounge chair, and as necessary, build the optimal chair using the Keystone's abundant options.

Choose solid wood arm caps for a clean, simple corporate use. Add casters or a tablet arm for institutional settings. No matter what its use, the Keystone's solid steel frame construction makes it a mainstay.

The Keystone Collection comes fully upholstered with arched arms and back. With its sturdy construction and multifaceted capabilities, the Keystone will hold its place in any room, for many years to come.



Metal Feet



Wood Feet



Caster Feet

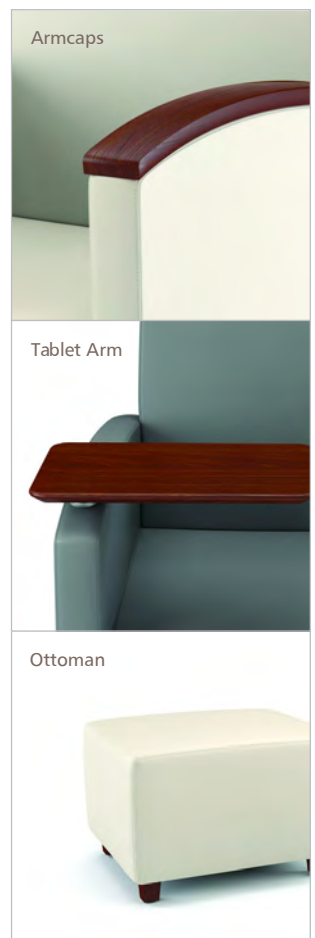



Lounge Chair



Lounge Chair  
with Tablet Arm

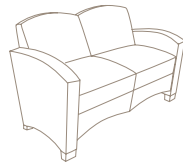

Two Seat Settee

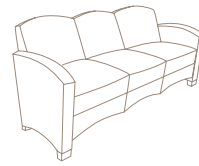

Three Seat Sofa



Ottoman

AGATI is defined by versatility. Designs combine a unique blend of aesthetics and engineering, distinguished by their eclectic styles. Inspired by the need for furniture that is both timeless and universal, AGATI is committed to the design and engineering of each and every piece.

Furniture built to last a lifetime means investing in the future. AGATI is dedicated to implementing sound environmental practices such as utilizing domestic reforested lumber, as well as reusable packaging materials. AGATI believes in helping preserve resources at no expense to the integrity of the product or the satisfaction of the customer.

Celebrated for its design. Chosen for its quality.

# AGATI

1219 W Lake Street Chicago, Illinois 60607 T 312.829.1977 F 312.829.8249 [www.agati.com](http://www.agati.com)

©2016 AGATI, Chicago, Illinois Printed in USA 11/10\_2M

# TUXEDO



The Tuxedo chair is long on style, short on frill. This fresh and simple lounge chair is accented by streamlined angles and modern lines. Constructed with a steel frame, the Tuxedo will provide comfort for a lifetime.

The Tuxedo is fully upholstered with square side panels. Its many options include solid wood, satin nickel or caster feet. Tailor any Tuxedo by choosing from solid wood arm caps, tablet arm option or matching ottoman. Visit [www.agati.com](http://www.agati.com) to see more.



Caster feet



Wood feet

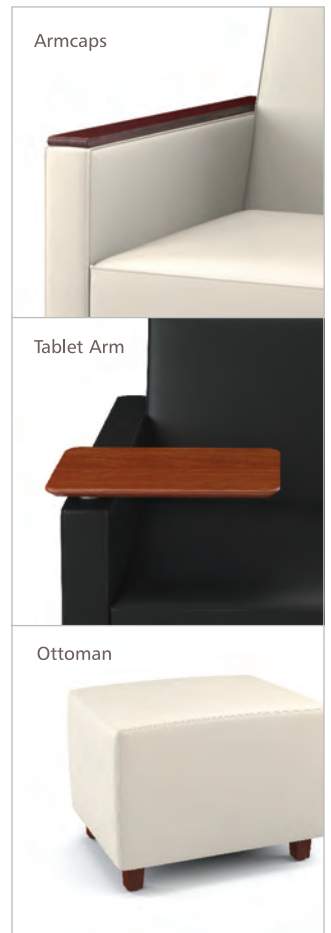





Lounge Chair  
Metal Feet



Lounge Chair  
with Tablet Arm  
Wood Feet

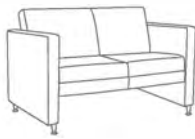

Two Seat Settee  
Metal Feet

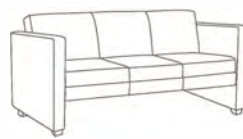

Three Seat Sofa  
Wood Feet



Ottoman

AGATI is defined by versatility. Designs combine a unique blend of aesthetics and engineering, distinguished by their eclectic styles. Inspired by the need for furniture that is both timeless and universal, AGATI is committed to the design and engineering of each and every piece.

Furniture built to last a lifetime means investing in the future. AGATI is dedicated to implementing sound environmental practices such as utilizing domestic reforested lumber, as well as reusable packaging materials. AGATI believes in helping preserve resources at no expense to the integrity of the product or the satisfaction of the customer.

Celebrated for its design. Chosen for its quality.



# AGATI

1219 W Lake Street Chicago, Illinois 60607 T 312.829.1977 F 312.829.8249 [www.agati.com](http://www.agati.com)

©2016 AGATI, Chicago, Illinois Printed in USA 8/12\_1M

# Wood Finish



Light Red Oak



Medium Red Oak



Dark Red Oak



Natural Cherry

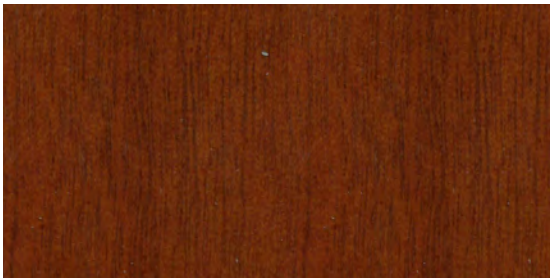

Medium Cherry

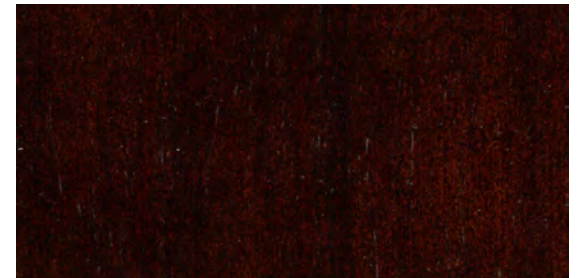

Dark Cherry

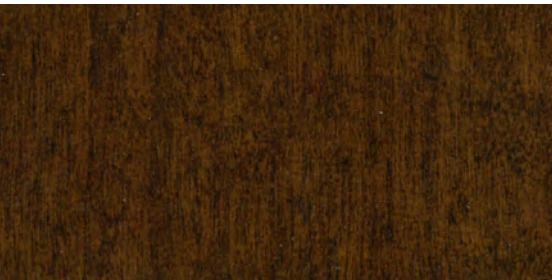

Walnut On Cherry



Natural Beech



Natural Maple

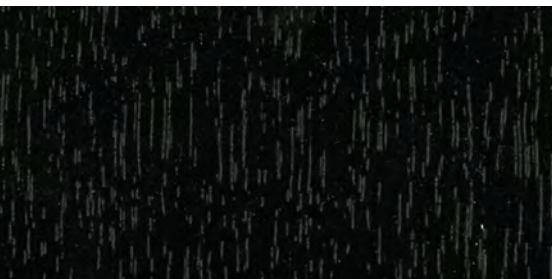

Oak with Espresso finish

\*Colors may vary by individual computer monitor from the actual final wood finish

\*For maximum fidelity, please order a sample, to ensure proper color match and actual image size.



Maple with Espresso finish

# Metal Finish

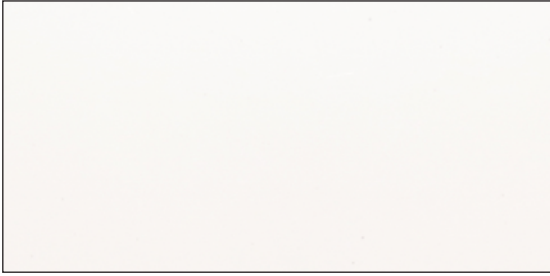

White

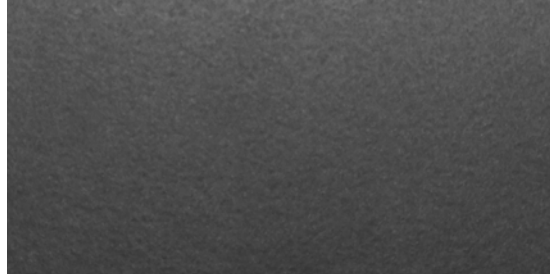

Grey Wrinkle

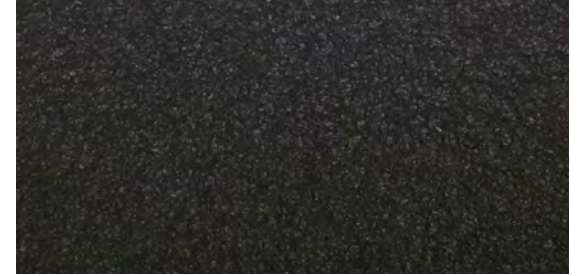

Black Wrinkle



Light Tone

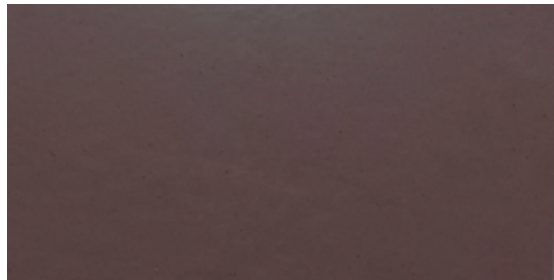

Medium Tone

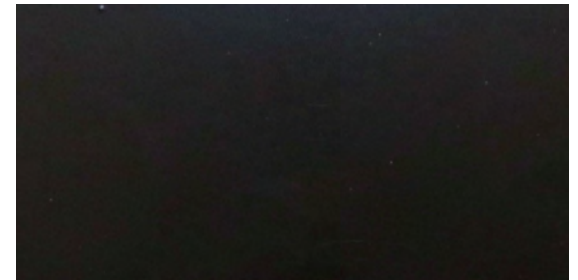

Dark Tone

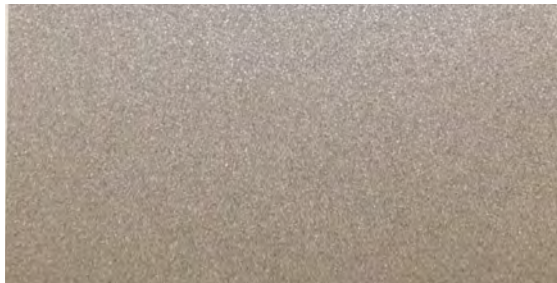

Argento 305

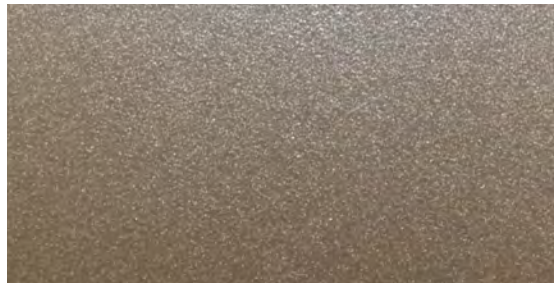

Argento 308

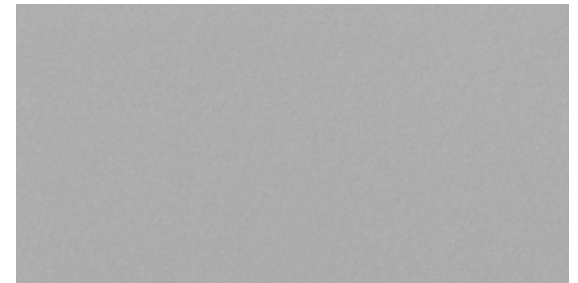

Metallic Silver



Stainless Steel (available on limited product)

\*Colors may vary by individual computer monitor from the actual final metal finish

\*For maximum fidelity, please order a sample, to ensure proper color match and actual image size.



## Wilsonart Laminates with a Matching PVC Edgeband

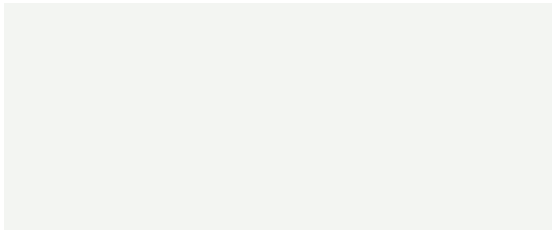

Frost White 1573-60  
Rehau C100033

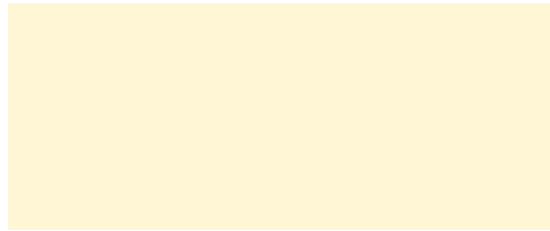

Antique White 1572-60  
Doellken 9366

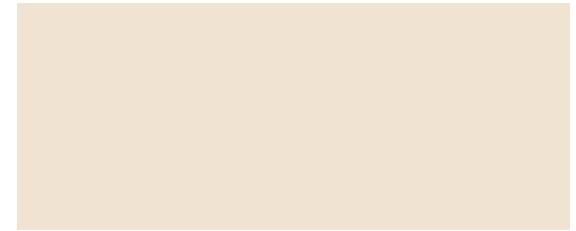

Light Beige 1531-60  
Rehau C100088

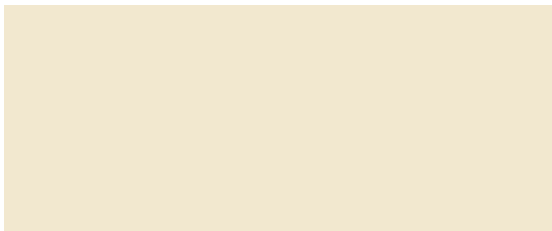

Natural Almond D30-60  
Doellken 2114

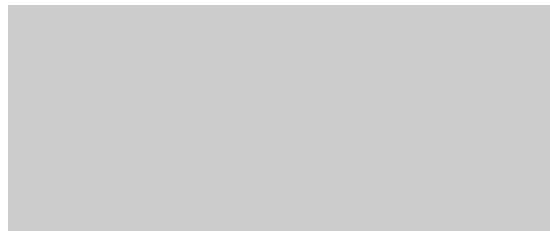

Fashion Grey D381-60  
Rehau C600004



Platinum D315-60  
Rehau C600063

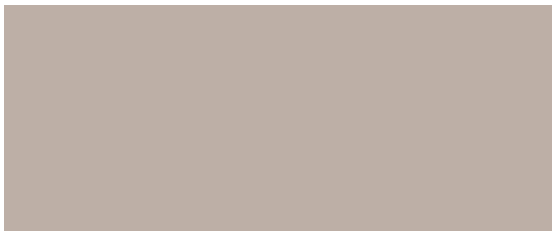

Pepperdust D327-60  
Doellken 2495



Dove Grey D92-60  
Doellken 2426

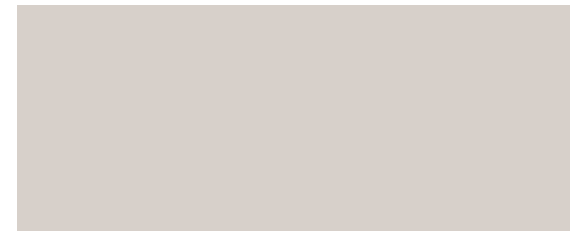

Grey 1500-60  
Doellken 2422



Khaki Brown D50-60  
Doellken 2240



Shadow D96-60  
Doellken 6397

## Wilsonart Laminates with a Matching PVC Edgeband



North Sea D90-60  
Doellken 2477



Slate Grey D91-60  
Doellken 2431



Brittany Blue D321-60  
Doellken 9244

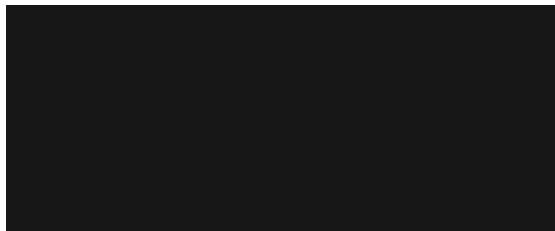

Black 1595-60  
Doellken 2416



Grey Nebula 4622-60  
Charter Industries W4622

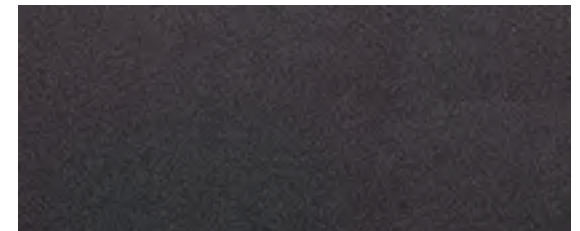

Graphite Nebula 4623-60  
Doellken 6623



Beige 1530-60  
Rehau C200063

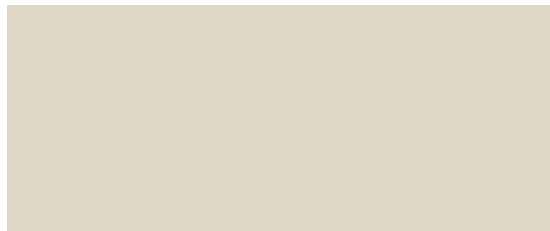

Putty 1503-60  
Rehau C200113

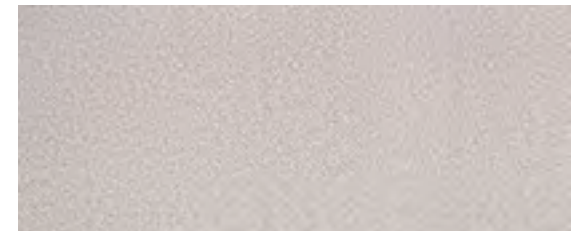

White Nebula 4621-60  
Rehau CP0077

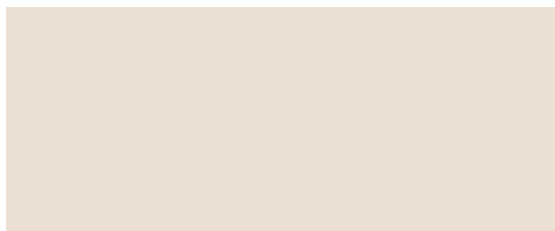

Wallaby D439-60  
Rehau C200087



Atlantis D25-60  
Rehau C500006

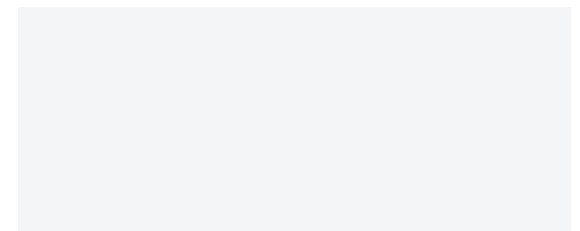

Designer White D354-60  
Charter Industries WD354

## Wilsonart Laminates with a Matching PVC Edgeband



Hunter green D79-60  
Rehau C700067



Port D14-60  
Rehau C300036

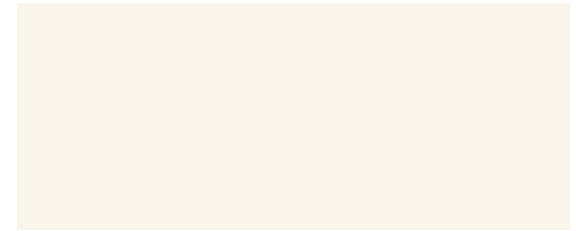

Alabaster D431-60  
Rehau C00187

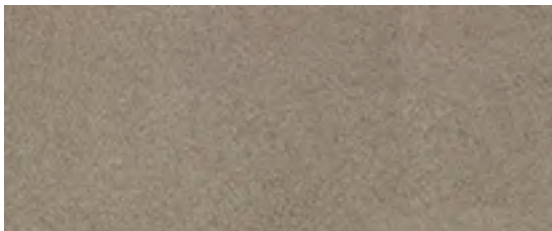

Bronze Legacy 4656-60  
Rehau CP20044



Grey Glace 4142-60  
Rehau CP10031

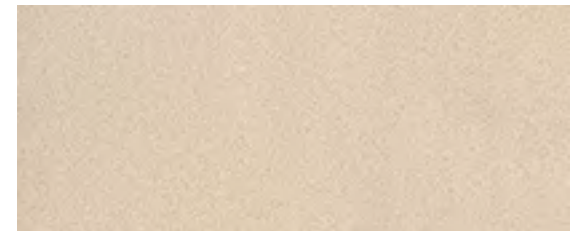

Neutral Glace 4143-60  
Charter Industries W4143

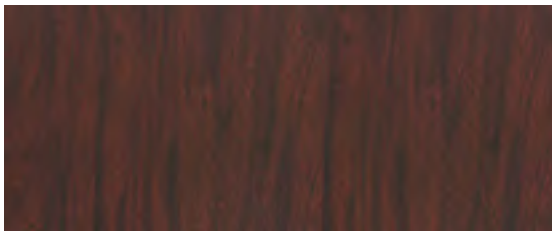

Figured Mahogany 7040-60  
Doellken 3796

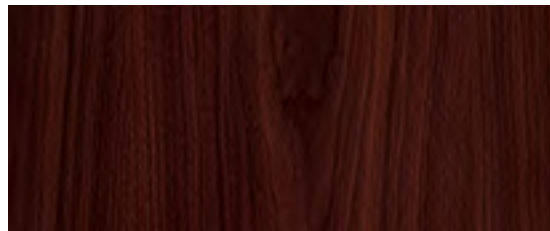

Empire Mahogany 7122-60  
Doellken 3796

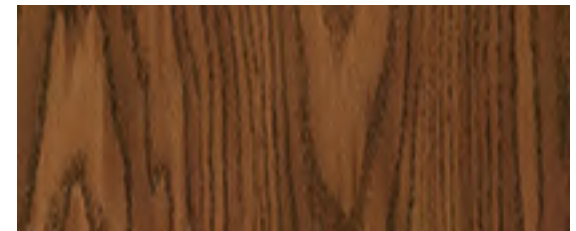

English Oak 7885-60  
Rehau CP40095

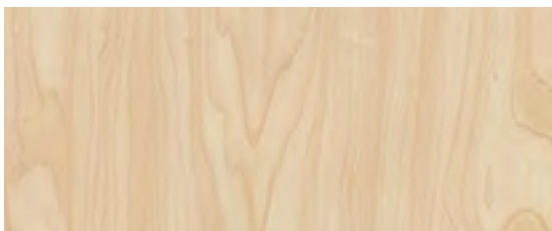

Manitoba Maple 7911-60  
Rehau CP20016



Limber Maple 10734-60  
Rehau CP20606



Kensington Maple 10776-60  
Doellken 4469



## Wilsonart Laminates with a Matching PVC Edgeband



Bannister Oak 7806-60  
Charter Industries W7806



Natural Pear 7061-60  
Rehau CP40065



Fonthill Pear 10745-60  
Doellken 4997

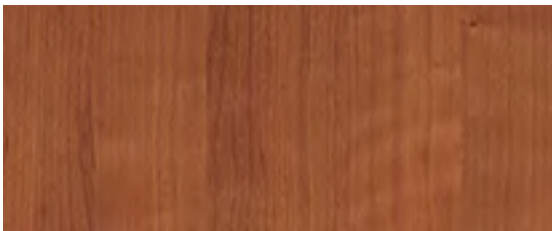

Amber Cherry 7919-60  
Doellken 8796YS



Tuscan Walnut 7921-60  
Rehau CP40466



Solar Oak 7816-60  
Rehau CP20599



Fusion Maple 7909-60  
Doellken 30364



Monticello Maple 7925-38  
Doellken 4894



Biltmore Cherry 7924-60  
Doellken 4893

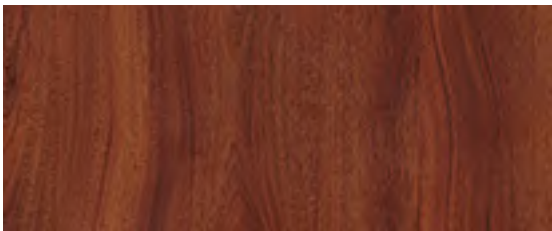

Windsor Mahogany 7039-60  
Doellken 3789



River Cherry 7937-60  
Doellken 5891

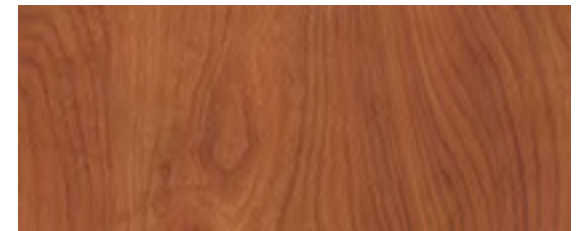

Wild Cherry 7054-60  
Doellken 3921

## Wilsonart Laminates with a Matching PVC Edgeband

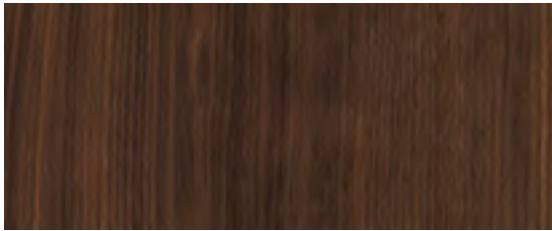

Columbian Walnut 7943-38  
Doellken 5963S



Cocobala 7942-38  
Rehau CP40416

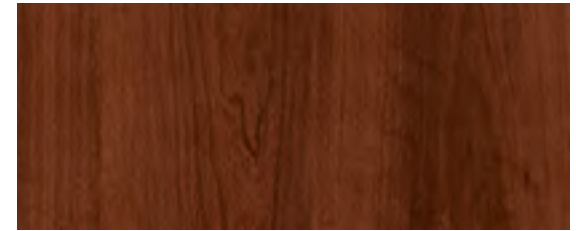

Williamsburg Cherry 7936-60  
Rehau CP40108

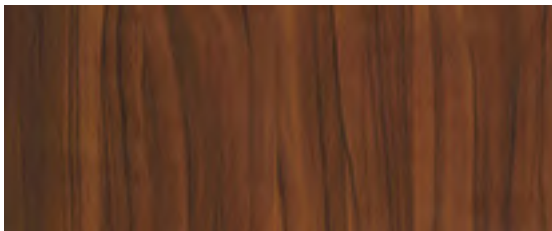

Mambo 7948-38  
Rehau CP40415



Huntington Maple 7929-60  
Rehau CP40603



Brazilwood 7946-60  
Rehau CP20118

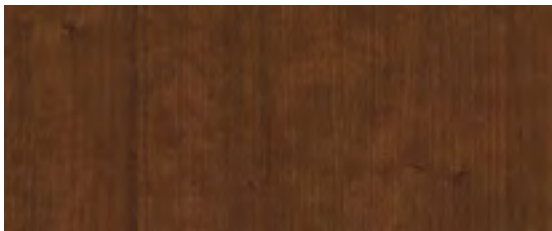

Shaker Cherry 7935-60  
Rehau CP40108



Beigewood 7850-60  
Rehau CP20567

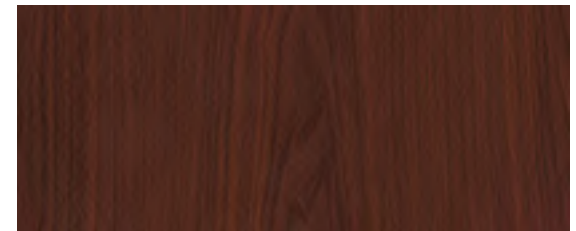

Briton Walnut 7922-60  
Rehau CP40223

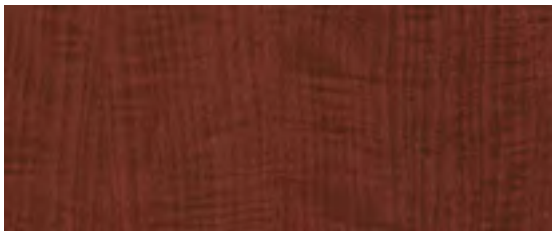

Versailles Aniger 7923-60  
Rehau CP40602t

\*Colors may vary by individual computer monitor from the actual final laminate product.

\*Please note that on quotes edge banding may vary between Charter, Doellken or Rehau depending on product availability. All edge bands will match the laminate.

\*For maximum fidelity, please order a sample, to ensure proper color match and actual image size.

\*Standard laminates are Series 60 and Series 38 laminates. All other laminates are premium and subject to an up charge.

# Sensi Laminate Colors



Stop Red 839



Spectrum Blue 851



Vibrant Green 6901



Clementine 2962



Chrome Yellow 1485



Cassis 6903

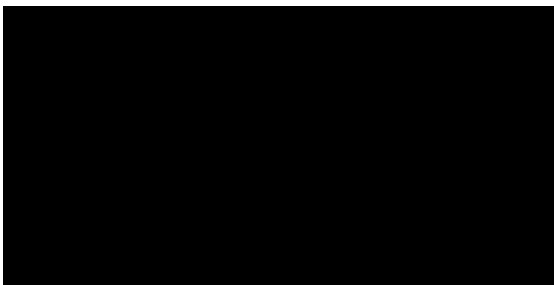

Black 909



Mouse 928

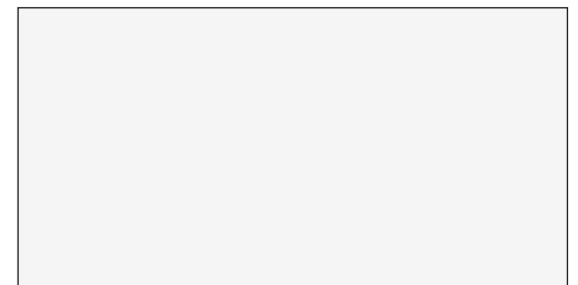

White 949



## Sensi Laminate Colors



Maple Woodline 6925



Macchiato Walnut 6932

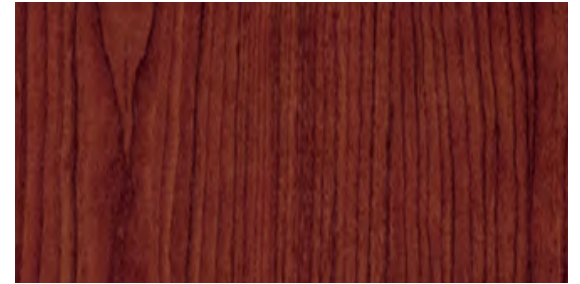

Select Cherry 7759



Zebrano 9011

\*Colors may vary by individual computer monitor from the actual final laminate product.

\*For maximum fidelity, please order a sample, to ensure proper color match and actual image size.

# Daltile Finish Card



Morning Frost



Simply White

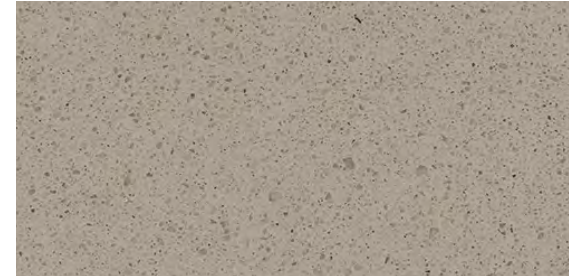

Ash Grey



Niagara

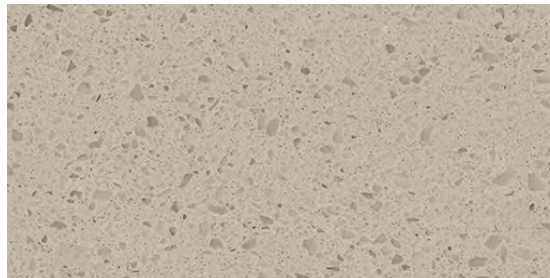

Simply Beige



Mesa Dune

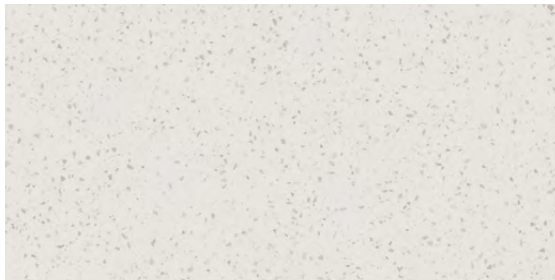

Woven Wool



Simply Grey

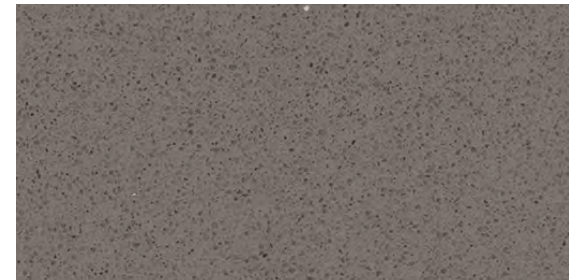

Brushed Flannel



Chipped Ice

\*Colors may vary by individual computer monitor from the actual final wood finish

\*For maximum fidelity, please order a sample, to ensure proper color match and actual image size.

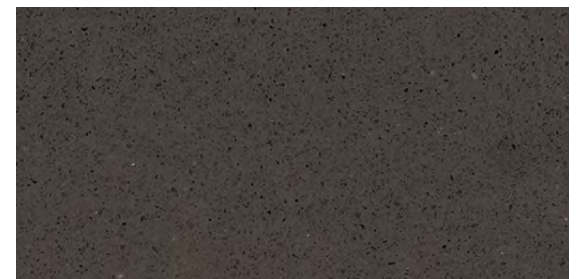

Concrete Grey



# Acoustical Panel Colors

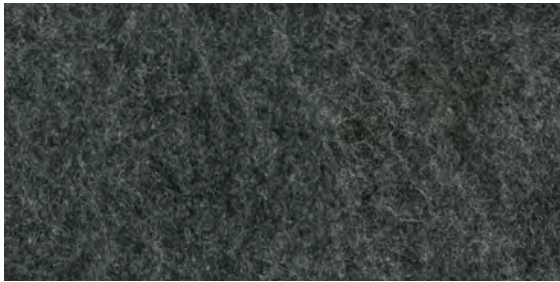

Slate



Tar

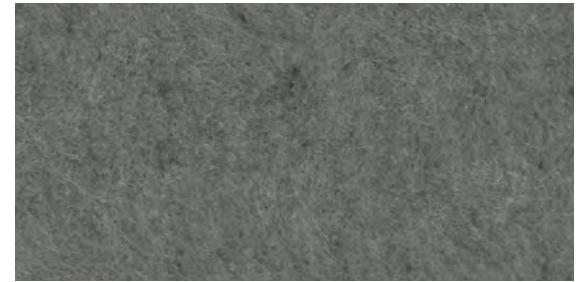

Fossil

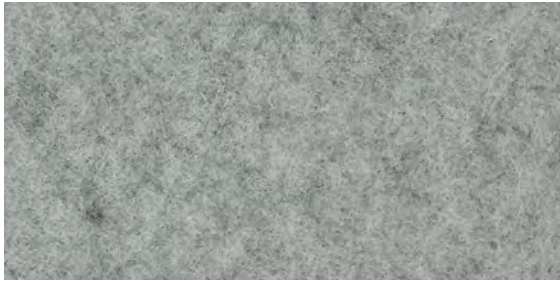

Greige



Linen



Ecrú



## Acoustical Panel Colors



Ochre

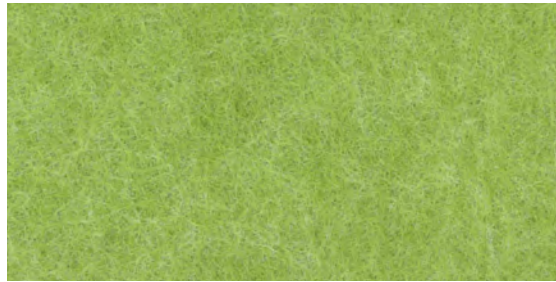

Grass

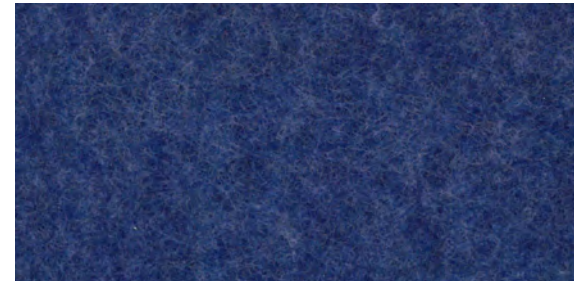

Cobalt

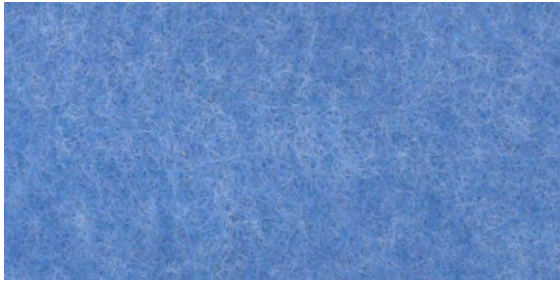

Sky



Mandarin

\*Colors may vary by individual computer monitor from the actual final panel product.

\*For maximum fidelity, please order a sample, to ensure proper color match and actual image size.

## Framework Acoustical Panel Colors



Marble

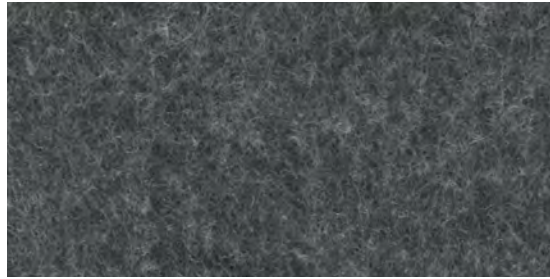

Grey

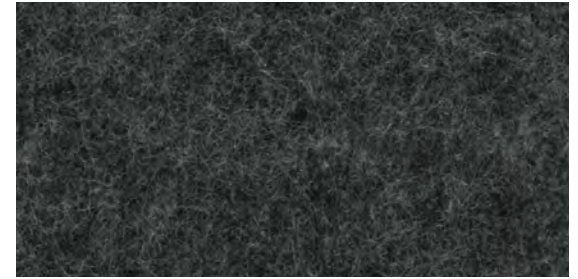

Pepper



Charcoal

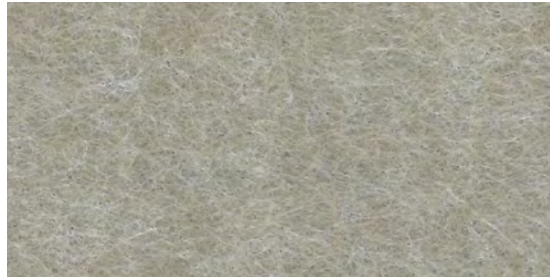

Oat

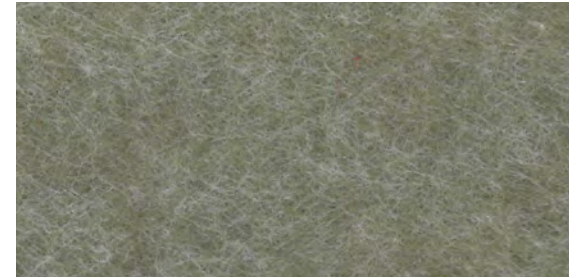

Stone

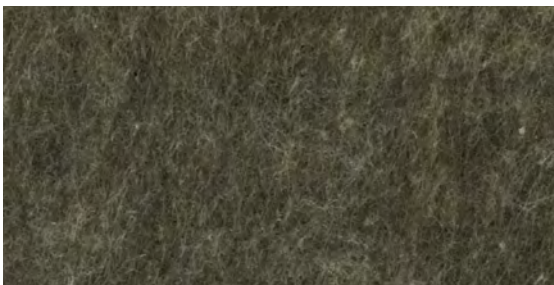

Earth Brown

## Framework Acoustical Panel Colors



Red

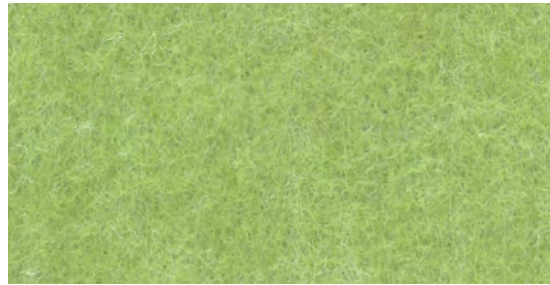

Pear



Midnight Blue



Teal



Pumpkin

\*Colors may vary by individual computer monitor from the actual final panel product.

\*For maximum fidelity, please order a sample, to ensure proper color match and actual image size.